



# Installation Guide

PVC PIPE FOR HDD & OTHER  
TRENCHLESS APPLICATIONS

M U N I C I P A L   S Y S T E M S

**IPEX FUSIBLE™**

**TerraBrute® CR**

**NOVAFORM™**



**IPEX**

by aliaxis

We Build Tough Products for Tough Environments®

## TABLE OF CONTENTS

Introduction .....	3
<b>IPEX Fusible PVC Pipe for Trenchless Applications</b>	<b>5</b>
The Fusion Process .....	6
Applications .....	6
<b>IPEX Fusible PVC Fusion</b>	<b>7</b>
<b>Standards and Specifications</b>	<b>8</b>
Fusible Series Pressure Pipe Letter of Compliance .....	8
Fusible Brute Pressure Pipe Letter of Compliance .....	9
AWWA C900 & AWWA C905 Hydrostatic Proof Test for Pipe .....	11
<b>Pipe Data</b>	<b>12</b>
<b>Pipe Handling</b>	<b>16</b>
Weather Conditions .....	18
Pipe String Layout .....	18
Rollers / Support .....	20
<b>Installation</b>	<b>21</b>
Bead Removal .....	21
Horizontal Directional Drilling .....	22
Pipe Bursting .....	22
Slip Lining / Casing .....	23
Direct Bury .....	23
Bridge Crossing .....	23
Insertion Pits .....	24
<b>Pipe Installation &amp; Handling Guide</b>	<b>26</b>
<b>Terrabrute® CR PVC Pipe for HDD &amp; Other Trenchless Applications</b>	<b>31</b>
Pull Strength .....	32
Applications .....	32
<b>Standards and Specifications</b>	<b>33</b>
<b>Dimensions</b>	<b>33</b>
Minimum Bending Radius – TerraBrute® CR Pipe .....	34
Joint Deflection Radius & Minimum Allowable Radius ...	34
Maximum Allowable Pull Force .....	34
<b>Joint Assembly Instructions</b>	<b>35</b>

<b>NovaForm™ PVC Liner for Sewer &amp; Culverts</b>	<b>41</b>
<b>Standards &amp; Specifications</b>	<b>42</b>
Material .....	42
Extruded Pipe .....	42
ASTM F1871 .....	42
Marking .....	42
Colour Coding .....	43
Packaging .....	43
<b>Pipe Data</b>	<b>43</b>
Weather Conditions .....	43
<b>Installation</b>	<b>63</b>
<b>Additional Considerations for Trenchless Installations with PVC</b>	<b>46</b>
<b>Pull Head</b>	<b>46</b>
<b>Cutting Pipe</b>	<b>49</b>
<b>Accessories</b>	<b>51</b>
<b>Restrainers</b>	<b>51</b>
<b>Service Connections</b>	<b>52</b>
Tapping .....	52
<b>Pressure Testing Procedures</b>	<b>55</b>
Basis for Hydrostatic Pressure Test .....	55
Preparations for the Hydrostatic Pressure Test .....	57
Determination of Test Pressure .....	59
Steps of the Hydrostatic Pressure Test .....	59
Procedures for Gravity Sewer Testing .....	61
Above Grade Testing .....	61
Hydrostatic Pressure Testing .....	62
Drill Stem .....	64

## Introduction

This booklet will answer the needs of pipe installers looking for general recommendations on how to install IPEX FUSIBLE™ PVC, TerraBrute® CR and NovaForm™ pipes. Out-of-the-ordinary conditions not covered here should be referred to the engineer or field inspectors to provide on-site solutions. In such cases IPEX's advice is always available. Our objective is to encourage the use of methods that lead to a professional installation that will ensure the maximum service life for the pipe.

The Engineer who designs the pipeline will determine how it is to be installed. It is not our intention that the Guide should assume that responsibility unless the Engineer so directs.

This booklet is an addition to our "Pressure Pipe Installation Guide" and "Sewer Pipe Installation Guide" and sets out the preferred methods of installation based on IPEX's experience and on a number of published reports from other industry sources. Users will find additional helpful advice in "Recommended Practice for the Installation of PVC Pressure Pipe", AWWA C605, published by the American Water Works Association.



Readers are invited to order a copy of the PVC Pipe Association Handbook of PVC Pipe - Design and Construction 5th Edition" (Hardcover Published December 2012). This comprehensive reference manual, with over 600 pages, covers all aspects of design and installation for PVC pipe & fittings.

Visit [www.uni-bell.org](http://www.uni-bell.org) to order.



## The Fusion Process

Fusible Brute and Fusible Series PVC pipe have distinctive properties allowing for full strength butt fusion joints. While other thermoplastic materials have been fused routinely, the patented fusion process incorporates a proprietary PVC formulation and a unique combination of heat, pressure and time, using slightly modified standard industry fusion machines.

All fusion times are comparable to other thermoplastic materials. All joints are fully restrained. Testing performed in accordance with ASTM D-638 methods, demonstrates that the tensile strength of the fused joint equals the tensile strength of the pipe.

## Applications

IPEX Fusible pipes can be installed using the following different methods:

- Horizontal Directional Drilling (HDD)
- Pipe Bursting
- Slip Lining
- Casing
- Direct Bury
- Bridge Crossing

This manual covers general installation recommendations as well as application specific recommendations.

## IPEX FUSIBLE PVC FUSION

Fusible Brute and Fusible Series pipes can only be fused by an approved IPEX Inc. licensee.

The list of current licensees is available through your local IPEX sales office at 1-866-473-9462.

### General Notes:

- All calculations are based on temperatures ranging from 4°C to 35°C
- All calculations are based on minimum allowable bend radius for pipe section
- Specifications for other sizes and DRs are available upon request.

## STANDARDS AND SPECIFICATIONS

Codes and standards applicable to the products with description of the products covered.

Fusible Brute and Fusible Series pipes come in 12.2 m (40ft) lengths; twice the length, and weight, of regular bell and spigot PVC pipe; and must be handled accordingly.

Fusible Brute pipes are capped at the plant.



### Fusible Series Pressure Pipe Letter of Compliance

#### Scope:

The letter of compliance covers IPEX Inc. requirements for PVC **Fusible Series** Pressure Pipe made to IPS outside diameters in a broad range of sizes and pressure capabilities. These pipes meet or exceed performance standards set by the American National Standards Institute (ANSI), the American Society for Testing and Materials (ASTM), CSA Group (CSA), Bureau de normalisation du Québec (BNQ) and NSF International (NSF).

**Fusible Series** Pressure Pipe is available in the following pressure ratings and nominal sizes:

Series 160 (SDR26) (160 psi) 4" thru 24" (100mm – 600mm)  
 Series 200 (SDR21) (200 psi) 4" thru 24" (100mm – 600mm)

**Fusible Series** Pressure Pipes are suitable for potable water supply lines, transmission mains, sewage force mains, golf course and other irrigation systems, oilfield salt water disposal, stormwater disposal, well casings, industrial process piping and other pressure applications.

#### Material:

PVC Poly(Vinyl Chloride) used in the manufacturing of **Fusible Series** Pressure Pipe complies with ASTM D1784, *Standard Specification for Rigid Poly(Vinyl Chloride) (PVC) Compounds and Chlorinated Poly(Vinyl Chloride) (CPVC) Compounds*, having a cell classification of 12454. The compound is listed with NSF for potable water service.

#### Extruded Pipe:

Extruded **Fusible Series** Pressure Pipe conforms to the following standards:

- ANSI/NSF 61 "Drinking Water System Components – Health Effects"
- ASTM D1599 "Standard Test Method for Short-Time Hydraulic Failure Pressure of Plastic Pipe, Tubing & Fittings"
- ASTM D2241 "Standard Specification for Poly(Vinyl Chloride) (PVC) Pressure-Rated Pipe (SDR Series)"
- CSA B137.0 "Definition, General requirements, and Methods of Testing for Thermoplastic Pressure Piping"
- CSA B137.3 "Rigid Polyvinyl Chloride (PVC) Pipe for Pressure Applications"

#### Marking:

Fusible Series Pressure Pipes are marked as prescribed in the above applicable standards to indicate size of the pipe, material designation, compliance to standard, and manufacturer's name or trademark.

#### Color Coding:

Fusible Series Pressure Pipe is color-coded white.

### Fusible Brute Pressure Pipe Letter of Compliance

#### Scope:

The letter of compliance covers IPEX Inc. requirements for 4" through 30" (100mm – 750mm) PVC **Fusible Brute** Pressure Pipe manufactured to cast iron outside diameters. These products meet or exceed performance standards set by the American National Standards Institute (ANSI), The American Society for Testing and Materials (ASTM), the American Water Works Association (AWWA), the Bureau de normalisation du Quebec (BNQ), CSA Group (CSA) and NSF International (NSF).

**Fusible Brute** PVC Pressure Pipe is suitable for conveyance of potable water in municipal distribution systems, sewer force mains, industrial process lines, irrigation piping and other pressure applications.

#### Material:

PVC Poly(Vinyl Chloride) used in the manufacturing of **Fusible Brute** Pressure Pipe complies with ASTM D1784, *Standard Specification for Rigid Poly(Vinyl Chloride) (PVC) Compounds*

and Chlorinated Poly(Vinyl Chloride) (CPVC) Compounds, having a cell classification 12454. The material also has a hydrostatic design basis of 4,000 psi (27.6 MPa). The compound is listed with NSF for potable water service.

#### Extruded Pipe:

Extruded **Fusible Brute** PVC Pressure Pipe conforms to the following standards:

ANSI/NSF-61 *"Drinking Water Systems Components – Health Effects"*

AWWA C900 *"Polyvinyl Chloride (PVC) Pressure Pipe and Fabricated Fittings 4" through 12" (100mm – 300mm), for Water Distribution"*

AWWA C905 *"Polyvinyl Chloride (PVC) Pressure Pipe and Fabricated Fittings 14" through 48" (350mm – 1200mm) for Water Transmission & Distribution:"*

BNQ NQ 3660-950 *"Safety of Products and Materials in Contact with Drinking Water"*

CSA B137.3 *"Rigid Poly(Vinyl Chloride) (PVC) Pipe for Pressure Applications"*

\* In accordance with the AWWA standards IPEX, as the manufacturer, has implemented a hydrostatic testing protocol that meets the proof test requirement in each AWWA standard. Specifically, at the beginning and end of each run/lot of the extruder, one length, either 6.1 metre or 3 metre, is tested. Our distributors, as purchasers, have agreed to this testing frequency.

Fusible Brute Pressure Pipe is available with the following nominal pressure ratings and nominal sizes;

PR305	(DR14)	(305 psi)	4" thru 12" (100mm – 300mm)
PR235	(DR18)	(235 psi)	4" thru 24" (100mm – 600mm)
PR165	(DR25)	(165 psi)	4" thru 30" (100mm – 750mm)

#### Capped Pipe:

Fusible Brute Pressure Pipe lengths are fitted with sealed end caps at IPEX's production facility to ensure maximum cleanliness of the pipes.

#### Markings:

Fusible Brute Pressure Pipes are marked as prescribed in the above applicable standards to indicate size of pipe, material designation, compliance to standard, and manufacturer's name or trademark.

#### Color Coding:

Fusible Brute Pressure Pipe is color-coded blue.

#### AWWA C900 and AWWA C905 Hydrostatic Proof Test for Pipe

A question that is often raised by engineers and owners concerns the hydrostatic proof testing of Fusible Brute™ pipe at the plant. Both AWWA C900 and C905 provide for the hydrostatic proof testing of pipe to verify the integrity of both the pipe and the bell. Each AWWA standard also allows for the modification of each testing protocol per agreement with the purchaser.

#### AWWA C900-07 standard states:

5.1.12 Hydrostatic proof test for pipe. Each length of pipe shall be proof tested in accordance with Sec. 4.3.3.3. (Hydrostatic integrity. The pipe, including any integral bell end or affixed coupling, shall not fail, balloon, burst, or weep when subjected to an internal pressure equal to 2.0 times its designated pressure class for a minimum dwell time of five seconds)

5.1.14 Optional test frequency. The purchaser or supplier may allow the manufacturer to conduct hydrostatic proof tests for pipes at frequencies other than required in Sec. 5.1.12. Each purchaser in the distribution chain shall be notified if this option is used.

#### AWWA C905-97 standard states:

5.1.8 Hydrostatic proof test for pipe. Each standard and random length of pipe shall be proof tested in accordance with Sec. 4.3.3.1 (Hydrostatic integrity. The pipe, including any integral bell end or affixed coupling, shall not fail, balloon, burst, or weep when subjected to an internal pressure equal to 2.0 times its pressure class for a minimum dwell time of five seconds)

5.1.9 Additional test requirements. The purchaser or supplier may allow the manufacturer to conduct hydrostatic proof tests for pipes at frequencies other than those required in Sec. 5.1.8.

#### IPEX Protocols:

IPEX, as the manufacturer, has implemented a hydrostatic testing protocol that meets the proof test requirement in each AWWA standard. Specifically, at the beginning and end of



## IPEX PIPE DATA – FUSIBLE BRUTE

### O.D. TYPE – CIOD

Nominal Size (mm)	Nominal Size (in)	DR	Avg. O.D. (mm)	Min. Wall (mm)		Avg. I.D. (mm)	Safe Pulling Force (lbf)	Pressure Rating (psi)	Critical Buckling Pressure (psi)	Min. Allowable Bend Radius (m)
100	4	DR 14	121.90	8.71		103.49	13,877	305	426	30.5
150	6	DR 14	175.30	12.52		148.78	28,736	305	426	43.9
200	8	DR 14	229.90	16.41		195.10	46,720	305	426	57.6
250	10	DR 14	281.90	20.14		239.26	71,499	305	426	70.4
300	12	DR 14	335.30	23.95		284.55	101,846	305	426	83.8
100	4	DR 18	121.90	6.78		107.53	10,984	235	190	30.5
150	6	DR 18	175.30	9.73		154.67	22,514	235	190	43.9
200	8	DR 18	229.90	12.80		202.90	38,492	235	190	57.6
250	10	DR 18	281.90	15.70		248.70	58,073	235	190	70.4
300	12	DR 18	335.30	18.62		295.82	81,924	235	190	83.8
350	14	DR 18	388.60	21.60		342.82	108,166	235	190	97.2
400	16	DR 18	442.00	24.60		389.90	139,838	235	190	110.6
450	18	DR 18	495.30	27.51		436.99	175,535	235	190	123.7
500	20	DR 18	548.60	30.50		484.00	215,617	235	190	137.2
600	24	DR 18	655.30	36.40		578.13	307,392	235	190	164.0
100	4	DR 25	121.90	4.88		111.58	7,982	165	67	30.5
150	6	DR 25	175.30	7.01		160.47	15,518	165	67	43.9
200	8	DR 25	229.90	9.20		210.42	26,616	165	67	57.6
250	10	DR 25	281.90	11.30		258.00	40,438	165	67	70.4
300	12	DR 25	335.30	13.41		306.89	57,247	165	67	83.8
350	14	DR 25	388.60	15.60		355.61	77,491	165	67	97.2
400	16	DR 25	442.00	17.70		404.50	99,719	165	67	110.6
450	18	DR 25	495.30	19.81		453.29	125,284	165	67	123.7
500	20	DR 25	548.60	22.00		502.01	153,768	165	67	137.2
600	24	DR 25	655.30	26.21		599.73	218,545	165	67	164.0

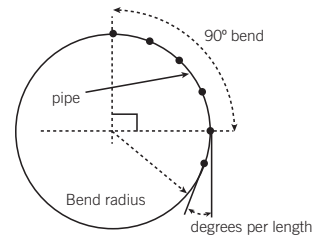



## IPEX PIPE DATA – FUSIBLE SERIES

## O.D. TYPE – IPS

Nominal Size (mm)	Nominal Size (in)	DR	Avg. O.D. (mm)	Min. Wall (mm)		Avg. I.D. (mm)	Safe Pulling Force (lbf)	Pressure Rating (psi)	Critical Buckling Pressure (psi)	Min. Allowable Bend Radius (m)
100	4	SDR 21	114.30	5.44		102.77	7,783	200	117	28.6
150	6	SDR 21	168.28	8.03		151.26	16,931	200	117	42.0
200	8	SDR 21	219.05	10.41		196.98	28,612	200	117	54.7
250	10	SDR 21	273.05	13.00		245.50	44,887	200	117	68.2
300	12	SDR 21	323.87	15.40		291.21	63,280	200	117	80.9
350	14	SDR 21	355.60	16.92		319.74	76,343	200	117	88.8
400	16	SDR 21	406.40	19.40		365.30	99,895	200	117	101.5
450	18	SDR 21	457.20	21.80		411.00	126,646	200	117	114.2
500	20	SDR 21	508.00	24.20		456.70	155,897	200	117	126.9
600	24	SDR 21	609.60	29.03		548.07	223,407	200	117	152.3
100	4	SDR 26	114.30	4.39		105.00	6,255	160	60	28.6
150	6	SDR 26	168.28	6.48		154.54	13,694	160	60	42.0
200	8	SDR 26	219.05	8.43		201.18	23,166	160	60	54.7
250	10	SDR 26	273.05	10.50		250.78	36,328	160	60	68.2
300	12	SDR 26	323.87	12.45		297.52	51,146	160	60	80.9
350	14	SDR 26	355.60	13.70		326.60	62,091	160	60	88.8
400	16	SDR 26	406.40	15.62		373.28	80,612	160	60	101.5
450	18	SDR 26	457.20	17.60		419.90	102,675	160	60	114.2
500	20	SDR 26	508.00	19.60		466.50	126,725	160	60	126.9
600	24	SDR 26	609.60	23.50		559.80	181,538	160	60	152.3

## Notes:

- PVC dimensions (minimum wall thickness and outside diameter) are per the IPEX Municipal Technical Manual - Vol 1.
- PVC safe pull stress of 7,000 PSI is based on the published value of 7,000-8,000 PSI for short term tensile strength and a safety factor of 2.5 [Unibell Handbook of PVC].
- PVC safe pull forces are based on minimum wall thickness and the safe pull stresses as calculated per Note 2.
- Pressure Ratings are per AWWA C900, AWWA C905 at 73°F.
- Critical Buckling Pressures are calculated using a Long Term Modulus of Elasticity (400,000 PSI for PVC), and published Poisson's Ratio [PVC Pipe Association Handbook of PVC]. No safety factor is included in the calculation for Critical Buckling Pressures.
- Bend Radius calculations are based on the assumption that a fitting or flange is present/to be installed in the bend. The Bend Radius for PVC includes a safety factor of 2.5 [PVC Pipe Association Handbook of PVC].

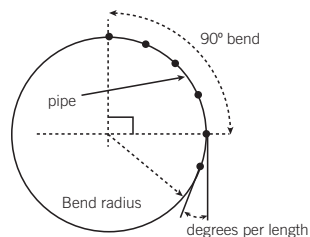

## PIPE HANDLING

### 1. Inspect Shipment

Be sure to check:

- Size (diameter)
- Thickness (DR Rating)
- Color
- Length
- Quantity

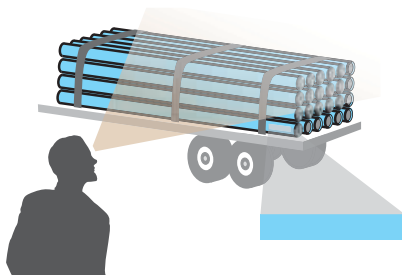

Inspect the pipe shipment prior to unloading for proper pipe size, type and color. Check for pipe damage or any other inconsistencies with the pipe load.

### 2. Lifting Mechanisms

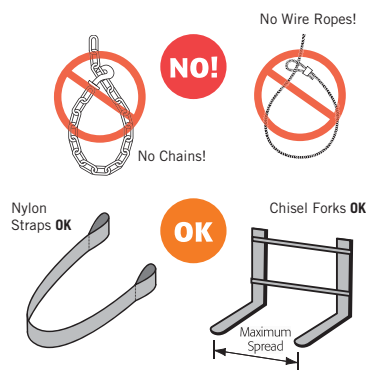

## WARNING

Pipe and pipe bundles may be extremely heavy and possibly unstable. Use caution in handling, loading, unloading and moving. Assure proper handling equipment is used and secured before attempting to move pipe or pipe bundles.

### 3. Moving and Unloading Pipe

**Straps:** For pipe lengths greater than 12.2 m (40ft), as well as individual pipe lengths 12.2 m (40ft) and greater.

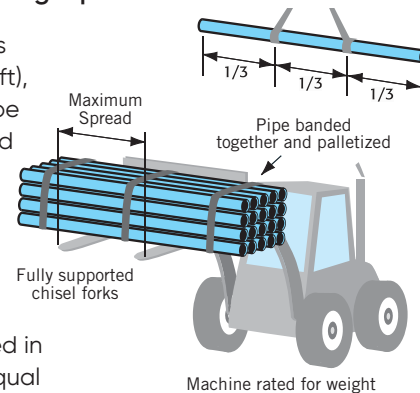

**Fork Lifts:** Pipe palletized in bundles, less than or equal to 40 feet in length.

**WARNING** Pipe and pipe bundles may be extremely heavy and possibly unstable. Use caution in handling, loading, unloading and moving. Assure proper handling equipment is used and secured before attempting to move pipe or pipe bundles.

### 4. Storage

If pipe is to be stored more than one year in direct sunlight, use opaque cover and allow air circulation around pipe to dissipate heat build-up.

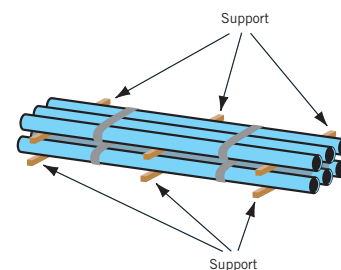

#### Storage

Pipe Diameter (in)	Maximum # of Rows Stacked
8 or less	5
10 to 21	4
24 to 30	3

## Weather Conditions

PVC Fusion can be performed year round; so long as the proper precautions are taken:

- Perform fusion inside a shelter to protect the joints from the elements; wind, rain, snow, dust, etc...
- Freezing conditions (below 4°C): heated shelter for the fusion equipment and the pipe must be kept at a temperature above 4°C prior to and during the fusion process.



## Pipe String Layout

The pipe string should be fused to the length required by the installation and as close as possible to where it will be installed.

Should deflections or bend be necessary in order to meet the requirement of a specific installation or limitations of the work space; the bends radius (refer to the Fusible PVC bends radius) or offset must not exceed these values:

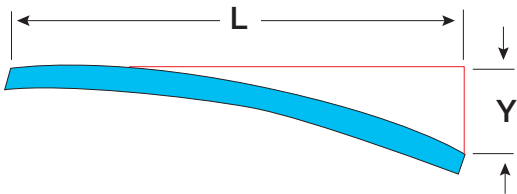

## Field Bend Offset "Y" (m) (5m – 25m) "L" (m)

Nominal Size (mm)	Nominal Size (in)	Field Bend Offset "L" (m)				
		5m	10m	15m	20m	25m
100	4	0.40	1.65	3.75	6.80	10.85
150	6	0.25	1.10	2.55	4.60	7.30
200	8	0.20	0.85	1.95	3.50	5.50
250	10	0.15	0.70	1.60	2.85	4.45
300	12	0.15	0.60	1.35	2.40	3.75
350	14	0.10	0.50	1.15	2.00	3.20
400	16	0.10	0.45	1.00	1.80	2.80
450	18	0.10	0.40	0.90	1.60	2.50
500	20	0.05	0.35	0.80	1.45	2.25
600	24	0.05	0.30	0.65	1.20	1.90

## Field Bend Offset "Y" (m) (30m – 50m) "L" (m)

Nominal Size (mm)	Nominal Size (in)	Field Bend Offset "L" (m)				
		30m	35m	40m	45m	50m
100	4	16.00	22.60	3.80	40.90	23.60
150	6	10.60	14.70	19.60	25.30	32.00
200	8	7.95	10.95	14.45	18.50	23.15
250	10	6.45	8.85	11.65	14.85	18.50
300	12	5.40	7.40	9.70	12.35	15.35
350	14	4.65	6.35	8.35	10.60	13.15
400	16	4.00	5.55	7.30	9.25	11.45
450	18	3.65	4.95	6.50	8.25	10.20
500	20	3.25	4.45	5.85	7.45	9.20
600	24	2.75	3.75	4.90	6.20	7.65

## Rollers / Supports

We recommend the use of properly sized rollers to support the pipe and help maintain the proper bend radius on the surface. The use of rollers also reduces the effect of drag force on the pull back and reduces the risks of possible damage when dragging the pipe over hard surfaces.

This table shows the maximum length between rollers when the pipe is empty:

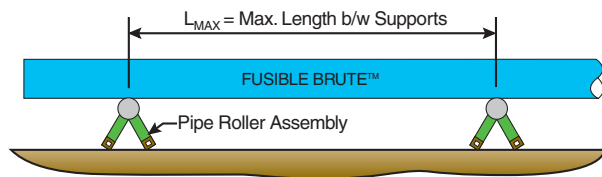

Nominal Size (mm)	Nominal Size (in)	Maximum Length Between Supports, Empty Pipe - $L_{MAX}$ (metres)
100	4	4.0
150	6	5.0
200	8	6.0
250	10	6.5
300	12	7.5
350	14	8.0
400	16	9.0
450	18	9.5
500	20	10.0
600	24	11.0

## INSTALLATION

### Bead Removal 14" and Up

For the outer bead, a router with a jig can be used to remove the bead right after the joint has cooled. The internal bead requires the use of a specialised tool and is not required in most installations. Leave at least 1/8" of the bead.



## Horizontal Directional Drilling (HDD)

Estimated pull forces must not exceed the Safe Allowable Pulling Force of the pipe; there are different tools and software available that can help determine the estimated pull force.

Ballasting the pipe will reduce drag forces in the bore hole and reduce the overall pull force required to install the pipe. Flow rate must be monitored to insure that the ballast water level inside the pipe is about the same as the drilling fluid level outside the pipe.

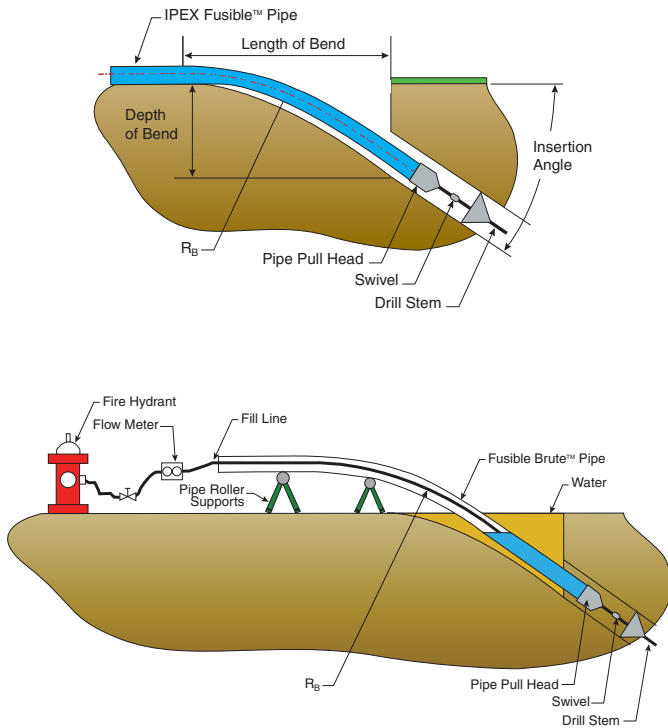

## Ballasting

## Pipe Bursting

A static burst head or cutter is required for pipe bursting installations.

## Slip Lining and Casing Installations

A minimum annular space of 2" (50mm) must be left between the existing and the new pipe for these installations. The use of casing spacers and grout is left to the discretion of the designing Engineer. See our Pressure Pipe Installation Guide for more details.

## Direct Bury

The string of pipe must be properly supported while lowered in the trench to prevent over bending.

1. Determine 'S' curve length from installation offset and your IPEX Fusible product.
2. Use machines at beginning, middle and end of 'S' curve to lift and place pipe.
3. Or install by utilizing a sloped insertion trench and by pulling pipe into place (See #2 illustration above).

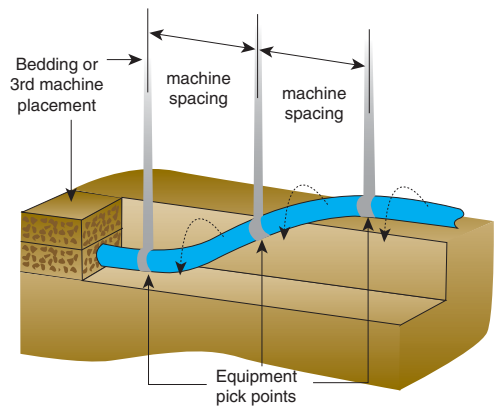

## Bridge Crossing

Please contact your IPEX Sales Representative when installing for bridge crossings.

## Insertion Pits

Insertion pits must be prepared in order to accommodate the minimum allowable bend radius of the pipe. A slide rule and smart phone application is available through IPEX in order to determine the dimensions of the pit based on the type of installation, pipe size, slope and depth.

The pipe can also be installed on supports or rollers, where there is not enough space to excavate the proper pit length, in order to get the proper bend radius.

### 'S' Curve - Slip Line or Pipe Burst Insertion

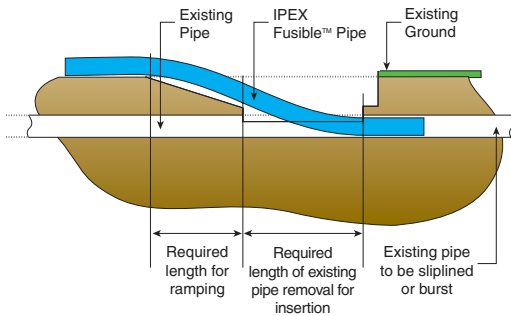

Contact your IPEX representative to:

- Determine 'S' curve length from depth of host pipe and size of Fusible Brute™ and Fusible Series™ pipe.
- Determine required length of pipe removal, pit and tail ditch from 'S' curve dimension.

## Horizontal Directional Drilling (HDD) Insertion

1. Determine insertion angle in degrees.
2. Determine length and depth factors from table, based on insertion angle.
3. Consult IPEX literature, website, or representative for the allowable bend radius (R<sub>b</sub>) to determine the required length of bend, and depth of insertion for your IPEX Fusible product.
4. Multiply the respective factor times the allowable bend radius (R<sub>b</sub>) to determine the required length of bend and depth of insertion for your IPEX Fusible product.

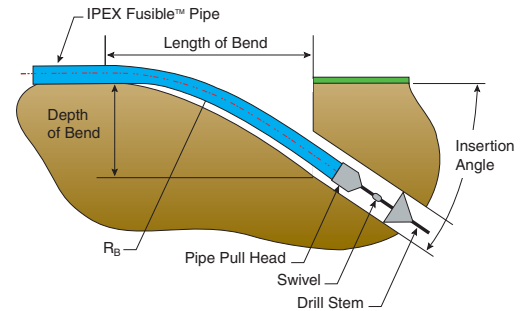

### Curve Length and Depth Factor from Insertion Angle

Insertion Angle (°)	Length Factor	Depth Factor
6	0.280	0.022
8	0.276	0.039
10	0.342	0.060
12	0.407	0.086
14	0.469	0.117
16	0.530	0.152

## PIPE INSTALLATION & HANDLING GUIDE

### PULLING FROM SURFACE

250

EXIT ANGLE OF HDD - ' $\alpha$ '	250		EXIT SLOPE OF HDD
2 Degrees	3.5	1	3.5 Percent
4 Degrees	5.5	1	7 Percent
6 Degrees	8	1	11 Percent
7 Degrees	9.5	1	12 Percent
8 Degrees	10.5	1.5	12 Percent
9 Degrees	12	1.5	16 Percent
10 Degrees	13	2	18 Percent
12 Degrees	15.5	2.5	21 Percent
14 Degrees	17.5	2.5	25 Percent
16 Degrees	20	3.5	29 Percent

PIT LENGTH - 'PL' (metres)      PIT DEPTH - 'PD' (metres)

## (DIPS / CIOD)

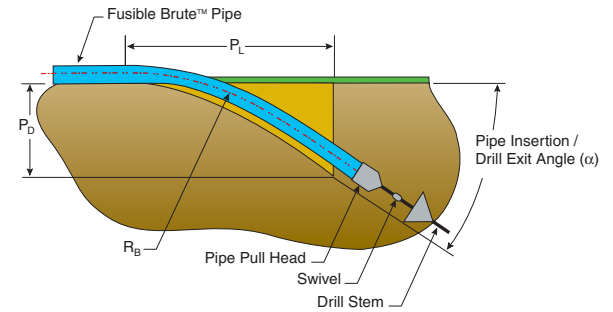

### LEGEND:

- RB = Minimum Allowable Bend Radius
- PL = Pit Length
- PD = Pit Depth
- $\alpha$  = Pipe Insertion/Drill Exit Angle

NOTE: Interpolate for distances of odd angle insertions

### PULLING FROM SURFACE

#### Nominal Pipe Size

100		150		200		250		300		350		400		450		500		600		750		900		
PL	PD	PL	PD	PL	PD	PL	PD	PL	PD	PL	PD	PL	PD	PL	PD	PL	PD	PL	PD	PL	PD	PL	PD	
2	1	2.5	1	2.5	1	3.5	1	3.5	1	4	1		4.5	1	5	1	5.5	1	6.5	1	8	1	9	1
2.5	1	4	1	5	1	5.5	1	6.5	1	7.5	1		8.5	1	9.5	1	10.5	1	12	1	15	1	17.5	1
4	1	5.5	1	6.5	1	8	1	9.5	1	11	1		12	1	13.5	1.5	15	1.5	18	1.5	22	2	26	2
4.5	1	6	1	8	1	9.5	1	11	1.5	12.5	1.5		14.5	1.5	16	2	17.5	2	20.5	2	25.5	2	30.5	2.5
5	1	7	1	9	1	10.5	1.5	12.5	1.5	14.5	2		16	2	18	2	20	2	23.5	2.5	29	2.5	34.5	3
5.5	1	7.5	1	9.5	1.5	12	1.5	14	2	16	2		18	2	20	2	22	2.5	26.5	2.5	32.5	3.5	38.5	3.5
6	1	8.5	1.5	10.5	1.5	13	2	15	2	17.5	2		20	2.5	22	2.5	24.5	2.5	29	3.5	36	4	43	4.5
7	1.5	9.5	2	12.5	2	15.5	2.5	18	2.5	21	2.5		23.5	3	26.5	3.5	29	3.5	34.5	4	43	5	51	6
8	1.5	11	2	14.5	2.5	17.5	2.5	21	3.5	24.5	3.5		27.5	4	30.5	4.5	34	5	40.5	5.5	50	6.5	59.5	8
9	2	12.5	2.5	16.5	3	20	3.5	23.5	4	27.5	4.5		31.5	5	34.5	5.5	38.5	6	46	7	56.5	8.5	67.5	10



PIPE INSTALLATION & HANDLING GUIDE

PULLING TO DEPTH

250

HOST PIPE INVERT - 'D'

HOST PIPE INVERT - 'D'

1.2 Metres	12.5	7	1.2 Metres
1.5 Metres	14.5	7	1.5 Metres
1.8 Metres	16.5	7	1.8 Metres
2.1 Metres	18	7	2.1 Metres
2.5 Metres	20.5	7	2.5 Metres
2.8 Metres	22	7	2.8 Metres
3.1 Metres	23.5	7	3.1 Metres
3.4 Metres	24.5	7	3.4 Metres
3.7 Metres	26	7	3.7 Metres
4.0 Metres	27.5	7	4.0 Metres

TAIL DITCH LENGTH - 'TDL' (metres)

PIT DEPTH - 'PL' (metres)

PULLING TO DEPTH

Nominal Pipe Size

100		150		200		250		300		350			400		450		500		600		750		900	
TDL	PL	TDL	PL	TDL	PL	TDL	PL	TDL	PL	TDL	PL		TDL	PL	TDL	PL	TDL	PL	TDL	PL	TDL	PL	TDL	PL
9.5	3.5	11	5	11.5	6	12.5	7	13	8.5	13	9.5		13.5	10.5	13.5	12	13.5	13	13.5	15.5	13.5	19	12.5	22.5
11	3.5	12.5	5	13.5	6	14.5	7	15	8.5	15.5	9.5		16	10.5	16.5	12	16.5	13	17	15.5	17	19	16.5	22.5
12	3.5	14	5	15.5	6	16.5	7	17	8.5	18	9.5		18.5	10.5	19	12	19.5	13	20	15.5	20.5	19	20.5	22.5
13.5	3.5	15.5	5	17	6	18	7	19	8.5	20	9.5		21	10.5	21.5	12	22	13	22.5	15.5	23.5	19	23.5	22.5
15	3.5	17	5	19	6	20.5	7	21.5	8.5	22.5	9.5		23.5	10.5	24.5	12	25	13	26	15.5	27	19	27.5	22.5
16	3.5	18.5	5	20.5	6	22	7	23	8.5	24.5	9.5		25.5	10.5	26.5	12	27	13	28.5	15.5	29.5	19	30.5	22.5
16.5	3.5	19.5	5	21.5	6	23.5	7	25	8.5	26	9.5		27	10.5	28	12	29	13	30.5	15.5	32	19	33.5	22.5
17.5	3.5	20.5	5	23	6	24.5	7	26.5	8.5	27.5	9.5		29	10.5	30	12	31	13	32.5	15.5	34.5	19	36	22.5
18.5	3.5	21.5	5	24	6	26	7	28	8.5	29.5	9.5		30.5	10.5	32	12	33	13	34.5	15.5	37	19	38.5	22.5
19	3.5	22.5	5	25	6	27.5	7	29	8.5	31	9.5		32	10.5	33.5	12	34.5	13	36.5	15.5	39	19	40.5	22.5

(DIPS / CIOD)

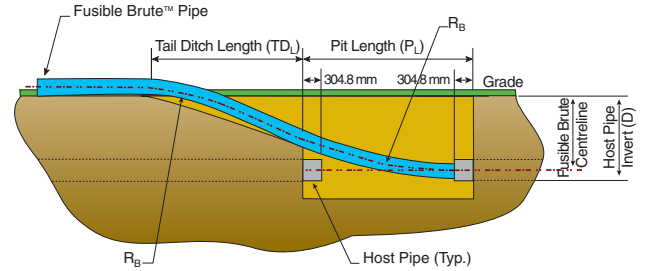

LEGEND:

- RB = Minimum Allowable Bend Radius
- PL = Pit Length
- TDL = Tail Ditch Length
- D = Host Pipe Invert

NOTE: Lengths may shorten due to slipline operations in a larger diameter host pipe. Contact your IPEX rep. for details.

NOTE: For pipe bursting installation, use the same numbers and add the tooling length, supplied by the tooling manufacturer, to the pit length PL dimension.



## Pull Strength

Developed in consultation with leading trenchless technology research experts, and rigorously tested in the field, TerraBrute CR trenchless PVC pressure pipe easily withstands the high tensile and bending forces that occur during HDD and other types of trenchless installation.

TerraBrute CR's non-metallic "ring-and-pin" gasketed joint design outperforms all other restrained PVC pipe joints on the market, providing more than twice the pull strength of other HDD systems – up to 390,000 lbs. (Ultimate) for 600mm / 24" pipe. Unlike competing square-shoulder designs, TerraBrute CR's rounded bell shoulders slide by roots, rocks and other debris that can protrude into the borehole. And unlike HDPE, TerraBrute CR requires no relaxation time before installation of fittings or services.

TerraBrute CR is an integral bell restrained joint PVC pipe. It is AWWA C900 pipe with slight modification that allows the joints to be locked, and the pipe used for "pulled in place" applications like horizontal directional drilling (HDD) or pipe bursting.

TerraBrute CR's locking system allows pipe to be assembled one length at a time, thus minimizing disturbance to the surrounding area and making TerraBrute CR the ideal choice for HDD projects located in tight areas.

## Applications

TerraBrute pipes can be installed for the following:

- Horizontal Directional Drilling (HDD)
- Pipe Bursting
- Bridge Crossings
- Seismic Zones
- Casing
- Steep Slopes

This manual covers general installation recommendations as well as application specific recommendations.

## STANDARDS AND SPECIFICATIONS

Codes and standards applicable to the products with description of the products covered.

AWWA C900: TerraBrute CR is made with pipe conforming to AWWA C900. However once the pipe is grooved on the spigot end its dimensions do not match those published in the C900 standard. Because of this small dimensional difference the pipe, once grooved, does not strictly conform to the C900 standard. It is important to note however, that TerraBrute CR is subjected to the same testing program as IPEX's Blue Brute (C900) pipe.

TerraBrute CR is certified to CSA B137.3, AWWA C900, NSF Std. 61, BNQ 3624-250\* and BNQ 3660-950\*

\* For BNQ Standards, not all sizes, pressure ratings, and manufacturing facilities are included in certifications.



## DIMENSIONS

When planning an HDD or pipe bursting project with TerraBrute CR, it must be remembered that it is a gasketed cast iron outside diameter (CIOD) pipe. This means that it will have a larger outside diameter than an IPSOD HDPE pipe of the same nominal size. In addition, the bell is the largest diameter on the pipe and must be accounted for when planning pre-ream operations.

### Dimensions

Product Code	Nominal Diameter		Pressure Rating (2:1 safety Factor) psi	Max outside Diameter (Bell OD)		AVG Internal diameter	
	in	mm		in	mm	in	mm
070258	4	100	305	6.49	165	4.09	104
070259	6	150	305	9.06	230	5.87	149
070260	8	200	235	11.33	288	8.03	204
070261	10	250	235	14.00	355	9.84	250
070262	12	300	235	16.36	416	11.69	297
070270	14	350	235	19.20	488	13.50	343
070271	16	400	235	21.60	549	15.35	390
070272	18	450	235	24.10	612	16.66	423
070273	20	500	235	26.80	681	18.46	469
070274	24	600	235	31.70	805	22.02	559

### Allowable Deflection & Minimum Allowable Radius

Nominal Size		Allowable Deflection degrees	Minimum Allowable Radius	
mm	in		meters	feet
100	4	14.2	24.1	79.0
150	6	12.5	27.5	90.2
200	8	10.5	32.9	107.9
250	10	7.5	46.3	151.9
300	12	7.1	49.0	160.5
350	14	3.5	99.7	326.9
400	16	3	116.4	381.5
450	18	2.5	139.7	457.9
500	20	2	174.7	572.5
600	24	1	349.5	1145.4

### Maximum Allowable Pull Force

Nominal Size		Maximum Allowable Pulling Force	
mm	in	kN	lbf.
100	4	50	11,200
150	6	110	24,700
200	8	115	25,800
250	10	187	42,100
300	12	275	61,800
350	14	356	80,000
400	16	445	100,000
450	18	578	130,000
500	20	712	160,000
600	24	867	195,000

## JOINT ASSEMBLY INSTRUCTIONS

The TerraBrute CR locking mechanism has been designed for easy installation. In fact, it is not much different than assembling a standard C900 joint.



### General Recommendations:

Pipe joints should be assembled using manual effort wherever possible. However if mechanical assistance is required, a pipe stop should be used to prevent over insertion. This can be easily accomplished by installing a standard restrainer grip ring or a clamp aligned with the insertion line on the spigot.

- 1 Locate the insertion line on the spigot end of each pipe. If the line is missing, it can be marked as follows. (see chart below)

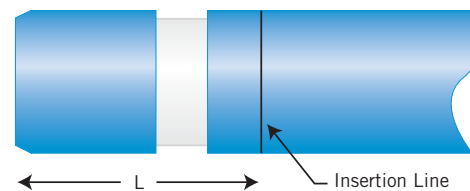

Pipe Size		Insertion Depth (L)	
in	mm	in	mm
4	100	195	7.7
6	150	218	8.6
8	200	253	10
10	250	268	10.6
12	300	293	11.5
14	350	318	12.5
16	400	372	14.6
18	450	397	15.6
20	500	422	16.6
24	600	432	17.0

- 2 Lube the spigot and gasket as you normally would when assembling a standard C900 joint.
- 3 Using a bar and block for smaller sizes (4" - 8") or mechanical means for larger sizes, line up the two pipes in a straight line and push the spigot into the bell. The pipe should be pushed until the line marked on the spigot is aligned with the end of the bell. Care must be taken not to over-insert the pipe as the locking pins may not line up with the inner groove.

While this can be easily controlled when using manual effort, it can be more difficult when using mechanical means such as a backhoe. In these cases it is recommended that a "pipe stop" be installed on the insertion line to prevent over insertion. A standard restrainer ring that can be removed after assembly will accomplish this.



- 4 Once the holes on the bell are aligned with the inner groove, line up the pins on the external half ring with the holes in the bell so that the half ring covers either the left or right side of the pipe.



**\*\*SAFETY GLASSES MUST BE WORN DURING PIN INSTALLATION.**

- 5 Using a 1 lb hammer, tap in the pins starting at the top of the pipe working your way down. The pins should be tapped until they bottom out on the inner groove or are flush with the ring. A good technique to ensure proper alignment, is to tap each pin on the ring 1/4 to 1/2 of the way in before hammering in fully. If the pins will not go all the way in, check to see if the rings, holes, and inner groove are properly aligned on all sides.



- 6 Check to make sure all of the pins are fully inserted before starting the next joint.

## ATTENTION

Ensure the inner groove is completely aligned with holes before inserting pins. All pins must be bottomed out on the inner groove after insertion.

When connecting to standard C900 pipe or fittings, cut off grooved portion and chamfer pipe edges as shown in the Installation Manual. **DO NOT** use the TerraBrute CR insertion mark as a guide for insertion into standard pipe or fittings – it is designed for the extended bell of TerraBrute CR.

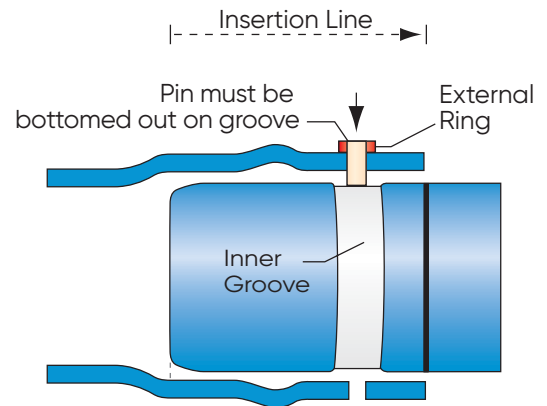
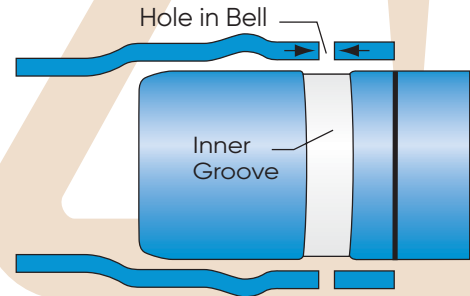







## STANDARDS & SPECIFICATIONS

NovaForm PVC Liner is manufactured and packaged onto a reel for transport and installation according to ASTM F1504. Made to order, varying lengths can be accommodated depending on the project's needs.

### Material

Poly Vinyl Chloride (PVC) used in the manufacturing of NovaForm PVC Liner complies with ASTM D1784, standard specification for Rigid Poly (Vinyl Chloride) (PVC) compounds and Chlorinated Poly (Vinyl Chloride)(CPVC) compounds, having a minimum cell classification of 12334 and with minimal physical properties as tested below:

<b>Tensile Strength</b>	Test Method D638	3,600psi (25MPa)
<b>Tensile Modulus</b>	Test Method D638	155,000psi (1069MPa)
<b>Flexural Strength</b>	Test Method D790	4,100psi (28MPa)
<b>Flexural Modulus</b>	Test Method D790	145,000psi (1000MPa)
<b>Heat Deflection Temperature (tested @ 264psi)</b>	Test Method D648	115°F (46°C)

### Extruded Pipe

Extruded NovaForm PVC liner conforms to the following standards:

#### ASTM F1504

Standard specification for Folded/Formed Poly (Vinyl Chloride) Pipe for Existing Sewer and Conduit Rehabilitation.

### Marking

NovaForm PVC Liners are marked as prescribed in the above applicable standards to indicate size of the pipe, material designation, compliance to standard, manufacturers name or trademark and length marker and linear distance.

### Colour Coding

NovaForm PVC Liner is colour coded white.

### Packaging

NovaForm PVC Liner is manufactured and coiled onto 4ft wide reels. Larger reels are available upon request. Special care shall be used when loading and unloading product during transport.

## PIPE DATA

Size	Average Installed OD (mm)	(in)	Min. Wall Thickness (mm)	(in)
150mm (6")	151.89	(5.98)	4.3	(0.17)
200mm (8")	202.44	(7.97)	5.7	(0.23)
250mm (10")	252.98	(9.96)	7.2	(0.28)
300mm (12")	303.53	(11.95)	7.4	(0.29)
375mm (15")	379.48	(14.94)	7.6	(0.30)
450mm (18")	457.20	(18.00)	6.8	(0.27)
600mm (24")	609.60	(24.00)	8.7	(0.34)
750mm (30")	762.00	(30.00)	10.8	(0.43)

\* Installed OD and wall thickness are functions of existing host pipe. Consult IPEX if host pipe internal dimensions vary from installed OD's.

### Weather Conditions

NovaForm PVC Liner installations can be performed year round, so long as the proper precautions are taken:

- Product conditioning is performed inside a shelter/tarped area to minimize heat losses to the elements: wind, rain, snow, etc.
- Host pipe is cleaned sufficiently to allow it to be lined. Any imperfections in the host pipe will be transferred to the NovaForm Liner and compromise the integrity of the system.
- Host pipe infiltration is minimal. As NovaForm PVC Liner requires heat to expand, any cold sinks produced through water infiltration minimizes the effectiveness during the processing phase.

## INSTALLATION

The NovaForm PVC Liner installation involves five key stages, briefly outlined below.

### 1 PREPARING

For any lining technology, host pipe preparation is key to a successful installation.

This step is common to many rehabilitation technologies and involves common practices such as:

- Identifying any conditions in the existing host pipe that could impede or prevent the proper installation of the liner.
- Accurately recording the position of all service connections.
- Remediating large quantities of groundwater infiltration, roots, collapsed pipe, dropped joints or offsets more than 12.5% of the inside pipe diameter, protruding taps, amongst other common defects.
- Cleaning/Flushing the line.
- Bypass control (if required).
- Traffic Control (if required).

For more information on these preparatory works, industry

### 2 CONDITIONING

associations such as NASSCO should be consulted for more information.

Prior to pulling the NovaForm PVC Liner into the existing host pipe, it first must be softened to allow it to be pulled from the shipping reel. This is typically accomplished by applying steam to the product until heated thoroughly. Thermocouples within the product reel allow the installer to monitor the temperature of the product during this stage.

### 3 PULLING

In order to process the NovaForm PVC Liner, it first must be pulled into place. This is typically accomplished through mechanical means by using a winch. A cable from the winch is fed from the downstream manhole ("B" side) to the upstream manhole ("A" side) and attached to the end of the NovaForm PVC Liner. It is then pulled into place using a series of rollers and shaping devices until it reaches the downstream manhole.

### 4 PROCESSING

Once in place, NovaForm PVC Liner is processed. Processing generally involves the following steps:

- The conditioning of pipe ends ("A" and "B" sides) in order to insert plugs which allow the passage of steam and air through the product.
- Additional conditioning throughout the entire product sufficiently to allow for expansion.
- Product expansion by increasing the steam pressure in the line, gradually.
- Transition to air to complete the expansion process and cool the liner. Once sufficiently cooled, the product and processing is completed.

### 5 FINISHING

Finishing involves the reinstatement of service connections and trimming of the liner ends. This step is performed with the aid of CCTV and robotic cutters. Common to many lining technologies, additional details on the finishing phase of the NovaForm PVC Liner installation process can be found through industry associations such as NASSCO.

## ADDITIONAL CONSIDERATIONS FOR TRENCHLESS INSTALLATIONS WITH PVC

### PULL HEAD

A proper pull head, designed to the specification of the pipe and to achieve the maximum allowable pull force recommendation is required. A conceptual design is available on demand.

In HDD installations it is important for the pull head to be water tight in order to prevent the drilling fluid from coming in or the ballast water from seeping out.

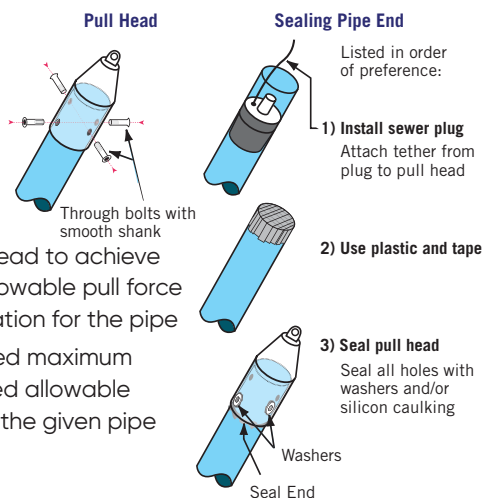

- Use pulling head to achieve maximum allowable pull force recommendation for the pipe
- Do not exceed maximum recommended allowable pull force for the given pipe selection

### Pulling Head Installation and Pipe End Sealing

#### Product Use Warnings

- Connections to the pull head clevis should be such that the pull head and the attached pipe are NOT allowed to rotate.
- The pull head clevis should NOT be modified to fit a non-compatible pulling mechanism.
- Components of the pulling mechanism, such as sub-assemblies, swivels, clasps and pins that will be located between the pull head and the pulling mechanism must be rated at or above the allowable pulling force for the IPEX Fusible PVC/TerraBrute CR pipe sections being installed.

- NEVER exceed the maximum allowable pull force for the Fusible PVC/TerraBrute CR pipe being installed.
- The end of the pipe being installed should be sealed prior to installation of the pull head to minimize the amount of foreign substance entering the interior of the pipe during pull-in. (see "Installing the Pull Head")

### Installing the Pull Head

1. **CAUTION:** Some pull heads are not designed to stop the drilling mud or other liquids from entering the pipe. Seal the end of the pipe using one of the following methods in order of most preferable to least preferable:
  - a. Insert a clean inflatable sewer plug into the end of the pipe ensuring that the plug has been inserted deeper than the deepest bolt holes. Inflate the plug until it seals with the inside of the pipe and tie off the plug to a cross bolt for easy retrieval. For extra sealing, follow step b or c below. Go to step 2.
  - b. If a clean sewer plug is not available, use a piece of thick plastic (possibly a garbage bag) and "Gorilla Tape" to seal the end of the pipe. The plastic or bag should be slid onto the end of the pipe and taped to the outer diameter of the pipe. Taping should then be done as shown in the diagram to seal the pipe-end as much as possible. Go to step 2.
  - c. If "Gorilla Tape" is not available, a minimum of 10.5 ml duct tape can be used. However, duct tape is not ideal for this application. Go to step 2.



2. Measure the outside of the pull head for the barrel length of the pull head to be used. Be sure not to measure past the barrel of the pull head into the cone portion. Measure the same distance from the end of the pipe on which the pull head will be installed and mark the position with a line using the marker.
3. Insert the pull head over the pipe until the pull head barrel reaches the general location of the line marked in step 2. The pull head is heavy and designed with a tight clearance so proper equipment should be used to mount the pull head. It might be necessary to push the pull head on with a piece of equipment.

4. Use a sharp (preferably new) hole saw or drill bit to drill holes in the pipe using the holes in the pull head as a template. When drilling, it is important to allow the teeth of the hole saw to do the cutting – putting additional pressure on the drill during this step could damage the pipe.
5. Cut the all thread stock to the proper size.

**CAUTION:** When cutting all thread it is possible for the threads to bend and not allow the installation of the smooth shank pull head nuts. Use the file to clean the threads and ensure that the pull head nuts can be threaded onto the all thread. Cross-threading will not give the proper amount of strength to the assembly and must be avoided. Each size pipe is different so care should be taken to ensure that the all thread will reach across the pipe.

**NOTE:** The all thread can always be trimmed but cannot be lengthened, so if there is any question as to the length, it is recommended that the all thread be cut longer than needed. If necessary, it can be cut again.

6. After complete installation of all hardware, “Gorilla Tape” should be used to seal the pull head as much as possible. “Gorilla Tape” should be installed over the pull head nuts and wrapped entirely around the pull head. Duct tape may be used, but is not preferred and may not result in a complete seal.
7. Use “Gorilla Tape” to seal off the edge of the pull head to the pipe in order to prevent (as much as possible) drilling mud leaking up the pull head.

**NOTE:** Silicone caulking can be used in concert with the “Gorilla Tape” to help seal the pull head. However, the caulking should only be used for sealing and cannot be used in lieu of the “Gorilla Tape. Again, duct tape may be used, but not preferable.

This process must be repeated for each individual pull. The pull head cannot be cut off and re-fused onto the end of the pipe as this could cause the pipe to fail at the pull head connections.

Please contact IPEX at 1-866-473-9462 with any questions regarding pull head installation or use.

## CUTTING PIPE

### Introduction

IPEX Fusible and TerraBrute CR pipe is made to water and wastewater industry PVC piping standards. Like regular PVC pipe, generally recommended practices for working with and handling PVC pipe apply to IPEX Fusible PVC/TerraBrute CR pipe. However, lengths of IPEX Fusible/TerraBrute CR pipe, are subject to stresses not generally experienced by standard 20 foot lengths of bell and spigot PVC pipe. These stresses are related to the configuration of the pipe and/or the method of installation. The purpose of this section is to provide recommendations regarding the proper procedures and requirements for cutting IPEX Fusible and TerraBrute CR pipe.

### Management of ‘Bending’ Energy

IPEX Fusible pipe is butt-fused together without mechanical joints or seals, therefore, this pipe assumes any changes in direction or grade by bending of the pipe barrel itself, rather than deflecting at joints or connections. Bending imparts longitudinal tensile and compressive energy on the pipe. Considering that project sites tend to have some relief to them, and that most installations require some bending of the pipe either before, during, or after installation; the bending energy needs to be managed during the cutting of an IPEX Fusible pipe string.

In an attempt to minimize the bending energy, every effort should be made to create as straight of an alignment as possible on both sides of the pipe cut. If the adjacent pipe alignment cannot be fully straightened, resistive support on the outside of the curved section should be provided to offset the tensile energy on the outside of the curve, on both sides of the cut. The pipe should always be fully supported on both sides of the cut and, when possible, the pipe should be cut on level ground. When the pipe to be cut is cantilevered, such as the end of a pipe string that is supported from only one side; the unsupported side should be strapped to completely support the weight of the cantilevered end.

## Management of 'Pulling' Energy

The installation of IPEX Fusible/TerraBrute CR pipe, particularly trenchless installations, will result in residual energy in the pipe after the installation has been completed. Such residual energy is the result of pulling the pipe into position, taking advantage of the tensile capacity of the pipe and joint.

In order to minimize or relieve the residual energy from pulling, it is recommended that the lead end of the installed pipe length be pushed back gently in the reverse direction of the installation. This compressive force will act to relieve residual tension on the pipe after being pulled. Ideally, the back end of the installed pipe should move slightly, showing that the entire pipe string has been compressively moved back through the final installation alignment. While this is ideal, it may not be possible in certain circumstances and installations, such as HDD installations.

### Recommended Procedure for Cutting IPEX Fusible PVC Pipe

Regardless of the steps taken to relieve the 'bending' and/or 'pulling' energy, it is possible that some residual energy might still remain in the Fusible pipe string at the cut location. When the pipe is cut in the hoop direction, or perpendicular to the length of the pipeline, any unrelieved longitudinal energy will act to pull the pipe apart. This can result in separation of the pipe, prior to being cut the entire way through. The cutting creates an initiation point in the direction perpendicular to the orientation of the longitudinal energy, which can open the pipe in the hoop direction prior to the completion of the cut. While this phenomenon is sometimes advantageous in that it 'completes the cut' prior to having to actually cut the entire pipe wall section – the 'cut-ends' are not always clean and perpendicular – particularly in situations where the longitudinal energy is uneven, such as with bent pipe.

To achieve as smooth of a cut face as possible, the following cutting procedure is recommended. This procedure will also help to confine the extent of the pipe separation to the intended cutting plane.

The following steps should be followed in order:

1. ALWAYS DOUBLE-CHECK TO MAKE SURE THAT THE PIPE IS NOT INTERNALLY PRESSURIZED. ALL INTERNAL PRESSURE MUST BE RELIEVED.
2. SCORE THE FULL CIRCUMFERENCE OF THE PIPE AND CUT ALONG THE SCORE LINE.

## ACCESSORIES

IPEX Fusible and TerraBrute CR pipes are made to the same dimensions as regular AWWA C900 and C905 PVC pipe and can be used with the same fittings and accessories. Fused joints are fully restrained and do not require mechanical restraints; however, both ends of a fused string of pipe must be restrained to the system it ties into.

## RESTRAINERS

### Tying IPEX FUSIBLE and TerraBrute CR pipe to a bell and spigot system

IPEX Fusible/TerraBrute CR products offer a fully restrained joint once assembled. As such, the assembled string of pipe ends up acting as a somewhat monolithic pipe. Once installed and pressurised, several phenomenon can generate « pull out » forces at the connection points between the fused or restrained section and the rest of the network or accessories (valves, tees, elbows, couplings, etc...) attached to it.

These forces can mainly be generated by:

- Movement in the bore hole
- Poisson Effect
- Pressure surges
- Water Temperature changes

In order to prevent the fused/restrained section from pulling out of a conventional gasketed joint; it must be restrained, through the use of a thrust block or mechanical restrainer, at both ends of the string to the rest of the system. The required length of gasketed joints to be restrained is project specific.

A conservative design would be to consider the fused/restrained string of pipe as a dead-end.

## SERVICE CONNECTIONS

### Tapping

Direct tapping for services is not recommended, tapped couplings or saddles **MUST** be used.

However,

### If you take the responsibility of Direct Tapping PVC in Trenchless Installations

In addition to the recommendations presented in the IPEX "BLUE BRUTE® PIPE TAPPING GUIDE", installers **MUST** follow these recommendations when direct tapping Fusible Brute and TerraBrute CR pipes:

- DO NOT DIRECT TAP PIPE THAT HAS BEEN GOUGED OR DAMAGED DURING THE INSTALLATION PROCESS,
- DO NOT DIRECT TAP IN A BENT SECTION OF THE PIPE,
- DO NOT DIRECT TAP PIPE UNDER TENSION.

It is the installer's responsibility to verify that the pipe is undamaged, unbent and not under tension before direct tapping.

The use of a saddle or tapped coupling is recommended to tap Fusible Brute/TerraBrute CR pipes. The following should be considered when using a saddle:

Use a saddle designed for PVC pipes.

- The spacing recommended for direct taps is conservative for a saddle tap.
- Tap no closer than 600 mm (24") from both the back of the bell and the spigot insertion line from joint.
- Stagger multiple taps and keep them at least 450 mm (18") apart lengthwise. Thus, the minimum spacing along the same line is 900 mm (36").
- Do not tap a curved pipe if the radius of the bend is less than 300 times the pipe outside diameter.

It is the installer's responsibility to ensure that the tap is properly done and provide warranty.



## Tapping Types for Pressure Application

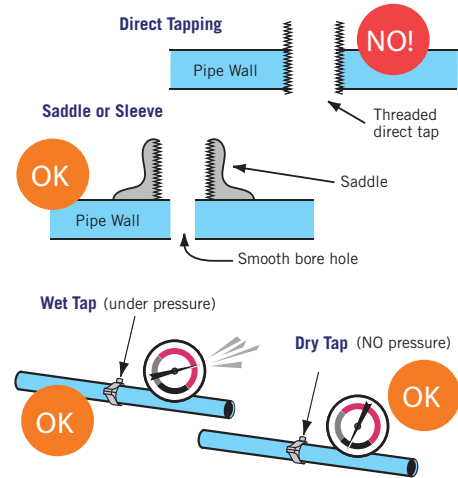

### Saddles and Sleeves

- IPEX recommends that all taps be performed with an appropriate saddle or sleeve
- Must be specifically designed for PVC
- Install per manufacturer's instructions

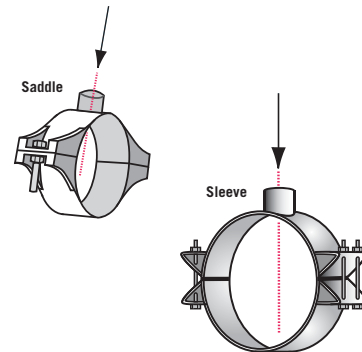

## Equipment

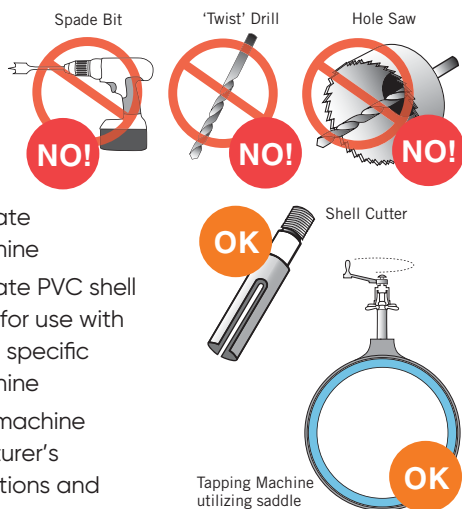

- Use appropriate tapping machine
- Use appropriate PVC shell cutter, made for use with manufacturer specific tapping machine
- Use tapping machine per manufacturer's recommendations and instructions

## Sizes Allowed

If a greater size tap is required than is shown below, alternate methods are available to accommodate the required size.

Pipe Size (In)	Recommended Tap Sizes					
	3/4"	1"	1-1/2"	2"	4"	6"
6	•	•				
8	•	•				
10	•	•				
12	•	•				
14	•	•				
16	•	•	•	•		
18	•	•	•	•		
20	•	•	•	•	•	
24	•	•	•	•	•	

## PRESSURE TESTING PROCEDURES

The pressure test is a key event in the installation of all IPEX Fusible and TerraBrute CR products, including Fusible Brute C-900®, C-905®, and FPVC™. There are, in a lot of installations, more events beyond the pressure test that define completion of the project. For pipe supply and fusion services however, the pressure test can define completion of services in the manner expected.

### Basis for Hydrostatic Pressure Test

In the majority of waterworks projects to date, the pipeline owner has determined the test pressure and duration of the pressure test for a fusible installation. The range of pressures has been from operating pressure of the system to 150% of the rated pressure of the pipe. The durations have been from 30 minutes to 24 hours. The normal average parameters have been 150% of the operating pressure of the system for a duration of 1 to 2 hours.

The primary standard used in pressure testing of PVC pressure water mains is the AWWA C605 "Underground Installation of Polyvinyl Chloride (PVC) Pressure Pipe and Fittings for Water". This standard states that the hydrostatic pressure test shall be performed at no less than 125% of the maximum anticipated sustained working pressure of the pipe, for a duration of 2 hours, unless this pressure exceeds the design pressure of the pipe or any of the appurtenances on the pipeline while performing the test.

AWWA C605 also contains the description of a "Test Allowance". This allowance is used for a typical gasketed pipe installation, and is defined as the "quantity of water that must be supplied to the pipe section being tested to maintain a pressure within 5 psi (34 kPa) of the specified hydrostatic test pressure".

Installations requiring more water than what is permitted by the test allowance will not be accepted. It should be noted here that a pipeline that is predominantly comprised of Fusible PVC, joined with butt-fusion joints and installed per the manufacturer's instructions, will not leak at the joints. This information regarding "Test Allowance" is for reference and those sections that contain gasketed fittings and connections or areas of other pipe technology. The following table provides the hydrostatic test makeup water allowance per 1000 feet:



## Procedures for the Hydrostatic Pressure Test

Hydrostatic test makeup water allowances per 1,000 ft (305 m) of PVC pipe\* – gph

Avg. Test Pressure		Nominal Pipe Diameter, in. (mm)						
psi	(kPa)	4 (100)	6 (150)	8 (200)	10 (250)	12 (300)	14 (350)	16 (400)
300	(2,070)	0.47	0.70	0.94	1.17	1.40	1.64	1.87
275	(1,900)	0.45	0.67	0.90	1.12	1.34	1.57	1.79
250	(1,720)	0.43	0.64	0.85	1.07	1.28	1.50	1.71
225	(1,550)	0.41	0.61	0.81	1.01	1.22	1.42	1.62
200	(1,380)	0.38	0.57	0.76	0.96	1.15	1.34	1.53
175	(1,210)	0.36	0.54	0.72	0.89	1.07	1.25	1.43
150	(1,030)	0.33	0.50	0.66	0.83	0.99	1.16	1.32
125	(860)	0.30	0.45	0.60	0.76	0.91	1.06	1.21
100	(690)	0.27	0.41	0.54	0.68	0.81	0.95	1.08
75	(520)	0.23	0.35	0.47	0.59	0.70	0.82	0.94
50	(340)	0.19	0.29	0.38	0.48	0.57	0.67	0.76

Avg. Test Pressure		Nominal Pipe Diameter, in. (mm)						
psi	(kPa)	18 (450)	20 (500)	24 (610)	30 (760)	36 (915)	42 (1,070)	48 (1,220)
300	(2,070)	2.11	2.34	2.81	3.51	4.21	4.92	5.62
275	(1,900)	2.02	2.24	2.69	3.36	4.03	4.71	5.38
250	(1,720)	1.92	2.14	2.56	3.21	3.85	4.49	5.13
225	(1,550)	1.82	2.03	2.43	3.04	3.65	4.26	4.86
200	(1,380)	1.72	1.91	2.29	2.87	3.44	4.01	4.59
175	(1,210)	1.61	1.79	2.15	2.68	3.22	3.75	4.29
150	(1,030)	1.49	1.66	1.99	2.48	2.98	3.48	3.97
125	(860)	1.36	1.51	1.81	2.27	2.72	3.17	3.63
100	(690)	1.22	1.35	1.62	2.03	2.43	2.84	3.24
75	(520)	1.05	1.17	1.40	1.76	2.11	2.46	2.81
50	(340)	0.86	0.96	1.15	1.43	1.72	2.01	2.29

## Preparations for the Hydrostatic Pressure Test

The pressure test is done after installation of the IPEX Fusible PVC/TerraBrute CR pipeline. The line is installed, and in the case of open cut, backfilled except for any mechanical connections made to the pipe. In the cases of horizontal directional drilling, pipe bursting, and slipline applications, the pipe is completely installed and the ends where connections are made or are to be made left exposed. Also, for any of the above that require service connections, taps, blow-off valves, air bleeds, etc. these should be installed to the extent possible before the test. The determination of what to test is based on the rating of the in-line or attached fittings or devices. Each component must be reviewed to determine if it can handle the prescribed test pressure. Normally those that can't handle 125% of the operating pressure are removed or isolated from the test. In situations where this can't be done, the test pressure is lowered. For example, a pressure relief valve by its design is set to typically release at a pressure slightly above operating pressure.

The test is run from the lowest accessible elevation point in the test section. This is because the pressure in the pipe is made up of two components. First there is the line pressure (dynamic pressure) generated by the attached test pump. Second is the static pressure generated from changes in elevation. With water, for every 2.3' (+/-) that the line elevation is higher than the test location, an additional 1 psi (+/-) of head pressure is added to the line pressure as measured at the test point. So if the test pressure is 150 psi and the pipe being tested has an elevation increase of 23 feet, the high point will see a pressure of 140 psi.

Another reason for testing from the lowest point is to gain some advantage in purging the entrapped air in the pipe. Air in the line during the pressure test is problematic and a safety concern. Air is very compressible. As it compresses, it stores energy, that when released can create a serious safety hazard. This does not pertain to the PVC pipe as much as it does to the end caps, restraints, and testing hardware. It is far more likely for testing hardware to become compromised during a test, and create a safety hazard. With an air pocket behind it, the end cap or other testing hardware can become a projectile. Air changes in volume with changes in temperature. It takes considerably longer to reach test pressure by compressing air than it does water.

Air is removed from the test section by venting and by flushing. In the case of venting, this may involve tapping into the PVC line to relieve air at high points. This could mean an excavation and tap saddle/sleeve operation. In most systems, air relief stations are included in the design for larger diameter transmission lines. Flushing is moving water through the line at high velocity, usually more than 3 ft/sec. This is more cost effective, but requires a disposal method for the water flushed if not done while the system is connected. Water is run at high velocity to move air along, and then the flow is stopped to allow the air trapped in the water during flow to migrate to the next high point in the system. This is repeated multiple times to remove air. Generally, moving approximately three volumes of water through the pipeline, with one volume being equal to the amount of water in the pipeline when full, provides sufficient flushing time. The recommendations of the current AWWA C605 and AWWA M23 should be followed for all flushing procedures.

The following figure is an example of flow rates and tap sizes needed to produce sufficient velocity to flush a water main:

## Recommended Flushing Parameters

Required Flow and Openings to Flush Pipelines  
(40 psi Residual Pressure in Water Main)

Pipe Dia. In.	Flow Required to Produce 2.5 fps Velocity in Main gpm	Size of Tap on Main by Number	Hydrant Size	Outlets
4	100	15/16	1	2-1/2
6	220	1-3/8	1	2-1/2
8	390	1-7/8	1	2-1/2
10	610	2-5/16	1	2-1/2
12	880	2-13/16	1	2-1/2
16	1565	3-5/8	2	2-1/2

\* With a 40 psi pressure in the main with the hydrant flowing to atmosphere, a 2-1/2 inch Hydrant outlet will discharge approximately 1000 gpm and a 4-1/2 inch hydrant nozzle will discharge approximately 2500 gpm

Normally testing is done with the line isolated from the balance of the system. To do this, end caps with taps for filling/draining water, measuring pressure, and connecting the test pump must be installed with the appropriate restraints. These are usually restraining glands designed for PVC or an equal type of PVC restraint. These parts must be procured with the end test pressure in mind. PVC restraints have a maximum pressure rating associated with them. There are special restraints that can increase the restraint pressure rating. In most cases, the end test hardware determines the maximum test pressure and not the pipe. All components of the system should be installed, checked, cured, and otherwise verified that they are capable of handling the test pressures associated with the test. This includes proper curing of any thrust or kick blocks installed on the pipeline.

The pressure test should be done with clean potable water in the case of water mains. Do not test with non-potable water. This could contaminate the system making disinfection harder and more costly.

## Determination of Test Pressure

Test pressure is normally based upon the working pressure of the piping system. Working pressure is the long term pressure at which the system is expected to operate. This is nearly always different, and less than the pressure class or pressure rating of the pipe.

## Steps of the Hydrostatic Pressure Test

The following steps are typically followed in a hydrostatic pressure test on a water main:

- 1 Complete installation of the pipe line.
- 2 Determine the test pressure.
- 3 Determine what appurtenances that meet the test pressure will be installed prior to the test and those that won't. Complete their installation. From a pipe supply stand point, the less "other devices" installed the more straight-forward the pipe pressure test is. These include mechanical flanges, MJ fittings, or threaded connections that will be susceptible points for a leak to occur that have nothing to do with the Fusible PVC pipe.

- 4 There are multiple different options for removing all of the air prior to a pressure test. Each one of the options outlined below will work as long as it is done properly. The most important item is to remove the maximum amount of air possible out of the line no matter how it is accomplished.
- Install a ductile iron mechanical flange with an offset threaded connection tap to fill and vent at the highest point of the line, add pressure to the line, and vent air from the line.
  - Install PVC tap saddles at the ends of the pipe orientated at the highest point of the line, add pressure to the line, and vent air from the line.
  - Install end caps to the pipe with threaded connection taps for water filling the line, adding pressure to the line, and venting air from the line.

**Note:** The end caps are usually tapped in the center. If venting is done from this location, it is highly likely that air will be trapped above the tap location. As a result, IPEX recommends installing screwed pipe fittings on the inside of the tap that allow an elbow and a pipe nipple pointing up toward the top of the end cap. This should come within 1/4" of the inside diameter of the PVC pipe being tested. Because the vent piping is on the inside of the end cap, it sees little to no pressure and therefore does not need to be watertight. Depending on the line configuration, the air vent can be reduced in size. If the line also will be flushed to remove air, then the vent line needs to be sized to handle the flow required for flushing. The end cap may also be tapped off-center and placed so that this off-center tap is at the top of the pipe cross-section, allowing a vent to be placed there that will remove the air that would normally be trapped at this location with a center-only type ductile iron cap arrangement.

If there are many changes in vertical direction, normally air vents are designed into the system. Where possible, these should be installed prior to a pressure test to facilitate venting of the line. Temporary taps and corporation valves or air relief valves can also serve to vent air pockets encountered during a pressure test situation, or they may be placed on the top of the pipe immediately before the end cap, to vent the trapped air above a center-only tapped DI end cap.

- 5 Fill line with water.
- 6 Vent line at all available and necessary locations.
- 7 Use flushing technique to remove air if venting alone does not remove air.
- 8 Connect positive displacement pressure test pump to the system.
- 9 Apply pressure with test pump to the predetermined test pressure.
- 10 Isolate pump from pipe for duration of test.
- 11 Apply any leak rate determination if applicable to the pressure test.

### Procedures for Gravity Sewer Testing (Low Pressure Air Test)

It is normal to test the integrity of a gravity sewer installation to confirm there is little or no infiltration or exfiltration from the new pipe. This is normally done with air. There are two main best practice standards that relate to the testing of sewer pipe with low-pressure air: 1.) ASTM F1417 – “Standard Test Method for Installation Acceptance of Plastic Gravity Sewer Lines Using Low-Pressure Air”; and 2.) UNI-B-6 – “Recommended Practice for Low-Pressure Air Testing of Installed Sewer Pipe.”

Generally, sewer pipe plugs are placed in the section to be tested. One is equipped with an air inlet and the other has a valve to release the air. One of the plugs, or the piping that the compressor attaches to, has a gauge to record the pressure in the pipe during the test. This is done at very low pressure, around 5 psi. Never test gravity lines (or pressure lines) with high pressure air.

### Above Grade Testing

Pressure testing a fused PVC line prior to installation is often requested. The issue is testing to show that the fusion joints are good prior to putting the pipe into the ground. While this is a legitimate concern, in practice it is very difficult and potentially unsafe to test above ground.

The fused pipe will be hundreds of feet in length with grade changes likely. This makes filling and removing air a time consuming proposition. The pipe is unsupported

allowing it to move. As pressure is added to the line after air is removed, the pipe will try to straighten itself causing movement over the ground. This movement is difficult to control and given the weight involved of a water filled line, an unsafe situation can develop. Finally, the end hardware must be secured above grade for such a test. If there is air in the line and the end hardware is not sufficiently restrained, the release of the end cap results in a fast moving projectile.

After pipe is fused above grade, it is subjected to tensile pull-in forces as well as bending. A test prior to installation therefore will miss any adverse effect of these. The only meaningful pressure test is one done after installation, on a line that is ready for acceptance into the system.

## Hydrostatic Pressure Testing

### 1. Basics for Test

- Determine test pressure and duration from the appropriate standards or specifications.
- General industry practice for testing is a one hour test at 150% of the long-term working pressure for the pipeline.
- Perform all testing under supervision and adhere to all applicable local standards.
- **WARNING** - Pressurized pipelines and attached appurtenances represent a potential safety hazard due to misinstallation, mis-handling or mis-testing of the pipeline.
- It is recommended that all pipelines be tested **AFTER** installation and burial, if applicable.
- Testing is to be completed hydrostatically. Removal of air is **MANDATORY**.
- General guidelines for hydrostatic pressure testing of PVC water piping systems can be found under AWWA C605 – Underground Installation of Polyvinyl Chloride (PVC) Pressure Pipe and Fittings for Water.

### 2. Check Appurtenances

- All restraint devices are installed per manufacturers' recommendations and appropriate torque
- All devices must be rated for test pressure
- Set up test at lowest elevation
- Remove air at the highest elevation(s)

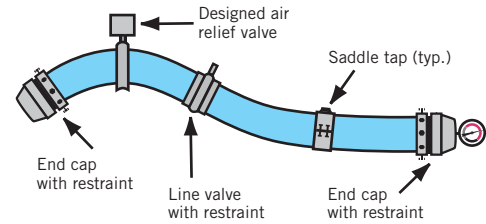

### 3. Purge Air

- Use designed air relief valves, air flushing with water, temporary testing air relief at end caps, or taps in line
- Assure all air is removed prior to test
- Let air settle out of test water before final venting

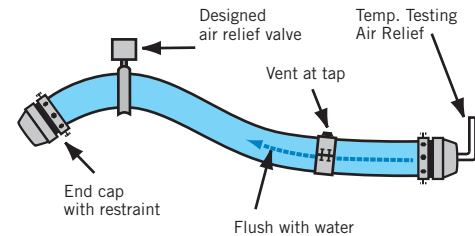

### 4. Perform Test

- Pressurize line
- Hold for test period
- Fix leaks, if any found
- Retest if necessary

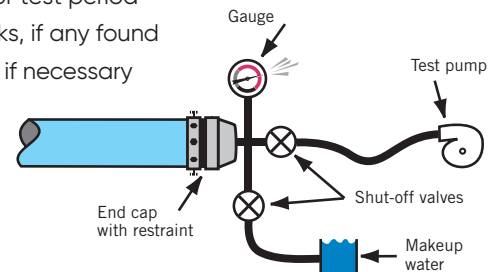

## Drill Stem

These tables are to be used as a reference only and should be validated with the drill stem supplier.

### Rod vs Pipe Deflection

Rod Length, ft		Allowable Deflection per Rod Length									
DIPS (in)	Radius (ft)	30		20		15		10		6	
		° Change	% Change	° Change	% Change	° Change	% Change	° Change	% Change	° Change	% Change
4	100	17.19	30.9%	11.46	20.3%	8.59	15.1%	5.73	10.0%	3.44	6.0%
6	144	11.94	21.1%	7.96	14.0%	5.97	10.5%	3.98	7.0%	2.39	4.2%
8	189	9.09	16.0%	6.06	10.6%	4.55	8.0%	3.03	5.3%	1.82	3.2%
10	231	7.44	13.1%	4.96	8.7%	3.72	6.5%	2.48	4.3%	1.49	2.6%
12	275	6.25	11.0%	4.17	7.3%	3.13	5.5%	2.08	3.6%	1.25	2.2%
14	319	5.39	9.4%	3.59	6.3%	2.69	4.7%	1.80	3.1%	1.08	1.9%
16	363	4.74	8.3%	3.16	5.5%	2.37	4.1%	1.58	2.8%	0.95	1.7%
18	406	4.23	7.4%	2.82	4.9%	2.12	3.7%	1.41	2.5%	0.85	1.5%
20	450	3.82	6.7%	2.55	4.4%	1.91	3.3%	1.27	2.2%	0.76	1.3%
24	538	3.19	5.6%	2.13	3.7%	1.60	2.8%	1.06	1.9%	0.64	1.1%
30	667	2.58	4.5%	1.72	3.0%	1.29	2.2%	0.86	1.5%	0.52	0.9%
36	798	2.15	3.8%	1.44	2.5%	1.08	1.9%	0.72	1.3%	0.43	0.8%
42	927	1.85	3.2%	1.24	2.2%	0.93	1.6%	0.62	1.1%	0.37	0.6%

### Rod vs Pipe Deflection

Rod Length, ft		Allowable Deflection per Rod Length									
IPS (in)	Radius (ft)	30		20		15		10		6	
		° Change	% Change	° Change	% Change	° Change	% Change	° Change	% Change	° Change	% Change
3	73	23.55	43.6%	15.70	28.1%	11.77	20.8%	7.85	13.8%	4.71	8.2%
	94	18.29	33.0%	12.19	21.6%	9.14	16.1%	6.10	10.7%	3.66	6.4%
6	138	12.46	22.1%	8.30	14.6%	6.23	10.9%	4.15	7.3%	2.49	4.4%
8	180	9.55	16.8%	6.37	11.2%	4.77	8.4%	3.18	5.6%	1.91	3.3%
10	224	7.67	13.5%	5.12	9.0%	3.84	6.7%	2.56	4.5%	1.53	2.7%
12	266	6.46	11.3%	4.31	7.5%	3.23	5.6%	2.15	3.8%	1.29	2.3%
14	292	5.89	10.3%	3.92	6.9%	2.94	5.1%	1.96	3.4%	1.18	2.1%
16	333	5.16	9.0%	3.44	6.0%	2.58	4.5%	1.72	3.0%	1.03	1.8%
18	375	4.58	8.0%	3.06	5.3%	2.29	4.0%	1.53	2.7%	0.92	1.6%
20	417	4.12	7.2%	2.75	4.8%	2.06	3.6%	1.37	2.4%	0.82	1.4%
24	500	3.44	6.0%	2.29	4.0%	1.72	3.0%	1.15	2.0%	0.69	1.2%







# CUSTOMER SERVICE CENTER

IPEX Inc.

Toll free: (866) 473-9462

ipexna.com

## About IPEX by Aliaxis

As leading suppliers of thermoplastic piping systems, IPEX by Aliaxis provides our customers with some of the world's largest and most comprehensive product lines. All IPEX by Aliaxis products are backed by more than 50 years of experience. With state-of-the-art manufacturing facilities and distribution centers across North America, we have established a reputation for product innovation, quality, end-user focus and performance.

Markets served by IPEX by Aliaxis products are:

- Electrical systems
- Telecommunications and utility piping systems
- Industrial process piping systems
- Municipal pressure and gravity piping systems
- Plumbing and mechanical piping systems
- Electrofusion systems for gas and water
- Industrial, plumbing and electrical cements
- Irrigation systems
- PVC, CPVC, PP, PVDF, PE, ABS, and PEX pipe and fittings

Products are manufactured by IPEX Inc.

IPEX Fusible™, Fusible Brute™, Fusible Series™, Go Trenchless with PVC™, TerraBrute® CR and NovaForm™ are trademarks of IPEX Branding Inc.

Fusible PVC™ is a trademark of Underground Solutions Inc. used under license.

i p e x n a . c o m

This literature is published in good faith and is believed to be reliable. However, it does not represent and/or warrant in any manner the information and suggestions contained in this brochure. Data presented is the result of laboratory tests and field experience.

A policy of ongoing product improvement is maintained. This may result in modifications of features and/or specifications without notice.