

# VOLUME I: PRESSURE PIPING SYSTEMS DESIGN

Municipal Technical  
Manual Series



## MUNICIPAL PRESSURE PIPING SYSTEMS

Blue Brute® Piping Systems  
Bionax® Piping Systems  
White Bionax® Sewer Pressure Piping Systems  
IPEX Centurion® Piping Systems  
IPEX Fusible™ Pipe  
TerraBrute® CR Piping Systems  
CycleTough® Piping Systems  
Blue904® Water Service Tubing  
Gold901™ Water Service Tubing  
Q-Line® Water Service Tubing



We Build Tough Products for Tough Environments®

# IPEX Pressure Piping Systems Design

## Municipal Technical Manual Series, Vol. 1

© 2021 by IPEX. All rights reserved. No part of this book may be used or reproduced in any manner whatsoever without prior written permission. For information contact: IPEX Management Inc., 1425 North Service Road East, Unit 3, Oakville, Ontario, Canada, L6H 1A7.

The information contained here within is based on current information and product design at the time of publication and is subject to change without notification. IPEX does not guarantee or warranty the accuracy, suitability for particular applications, or results to be obtained therefrom.

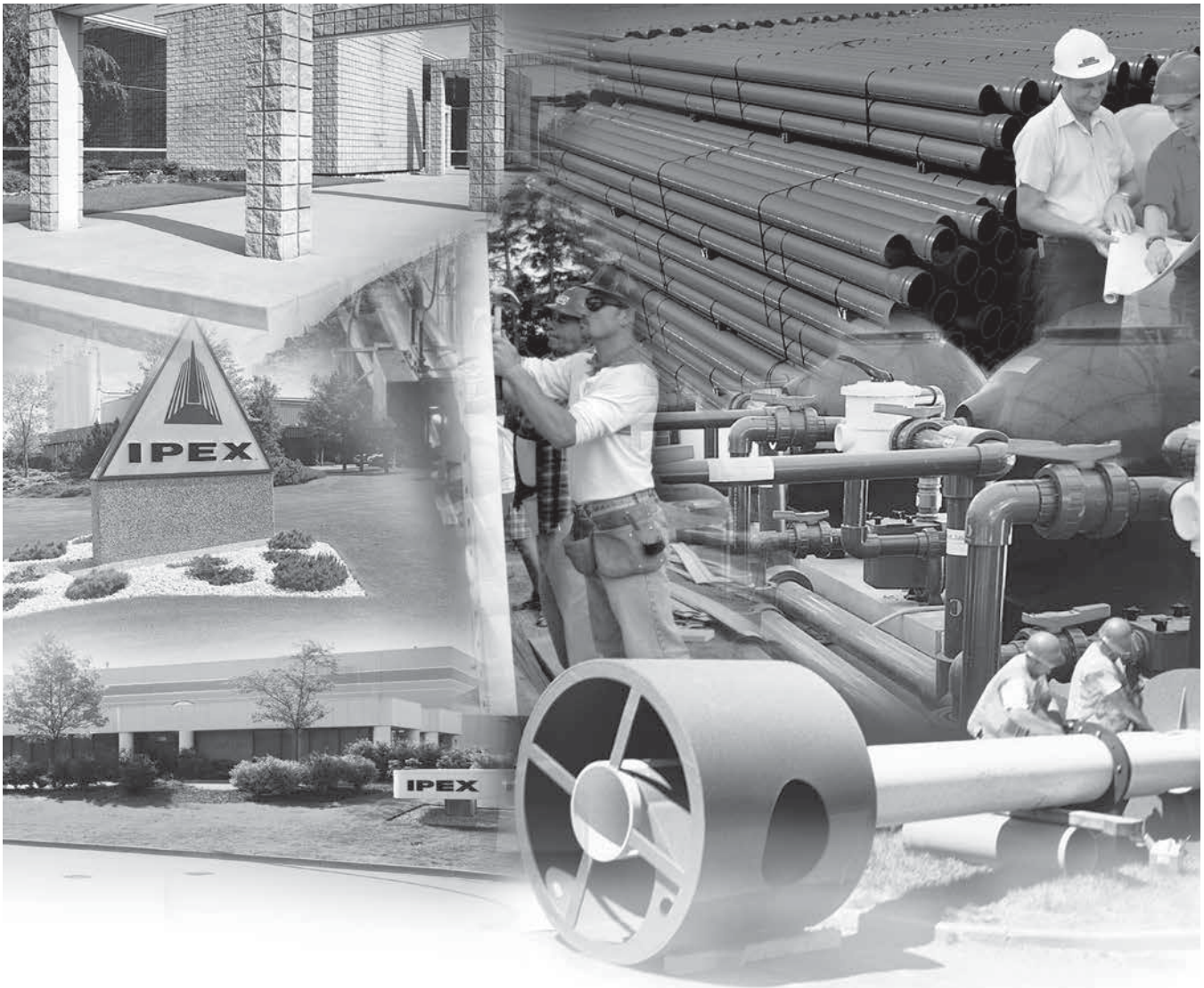

## ABOUT IPEX

At IPEX, we have been manufacturing non-metallic pipe and fittings since 1951. We formulate our own compounds and maintain strict quality control during production. Our products are made available for customers thanks to a network of regional stocking locations throughout North America. We offer a wide variety of systems including complete lines of piping, fittings, valves and custom-fabricated items.

More importantly, we are committed to meeting our customers' needs. As a leader in the plastic piping industry, IPEX continually develops new products, modernizes manufacturing facilities and acquires innovative process technology. In addition, our staff take pride in their work, making available to customers their extensive thermoplastic knowledge and field experience. IPEX personnel are committed to improving the safety, reliability and performance of thermoplastic materials. We are involved in several standards committees and are members of and/or comply with the organizations listed on this page.

For specific details about any IPEX product, contact our customer service department (contact information is listed on the back cover).



# CONTENTS

## Pressure Piping Systems Design Manual

Overview.....	1
<b>Section One: Product Information</b>	
Introduction.....	3
Summary of Pressure Pipe and Fittings Testing.....	4
Blue Brute® Piping Systems.....	5
Bionax® Piping Systems.....	11
White Bionax® PVCO pipe.....	12
IPEX Centurion® Piping Systems.....	13
IPEX Fusible™ PVC Pipe for Trenchless Applications.....	18
TerraBrute®CR Restrained Joint Pipe.....	22
CycleTough® Piping Systems.....	26
Blue904® PEX Water Service Tubing.....	34
Gold901™ Water Service Tubing.....	36
Q-Line® Water Service Tubing.....	38
Standards for PVC Pressure Systems.....	41
<b>Section Two: Properties of PVC Pressure Pipe and Pressure System Design</b>	
Introduction.....	43
Material Properties of PVC.....	43
Design Life.....	43
Design Strength.....	44
Chemical Permeation and Installation of PVC Pipe in Contaminated Soils..	44
UV Resistance.....	45
Thermal Effects - Pressure Derating.....	45
Thermal Effects - Expansion and Contraction.....	45
<b>Design Calculations</b>	
Calculating a Pressure/Class Rating.....	46
Calculating Friction Headloss.....	46
Calculating Surge Pressures.....	47
Calculating Wave Velocity.....	48
Air Entrapment in Pipelines.....	48
Cyclic Design for PVC Pipes.....	50
Thrust Restraint in Gasketed Piping Systems.....	52
Assembly, Installation and Testing of PVC Pressure Pipe Systems.....	53
<b>Section Three: Design Examples</b>	
#1: Sewage Forcemain – AWWA C900 PVC Pipe.....	55
#2: Sewage Forcemain – ASTM F1483 PVCO Bionax Pipe.....	59
#3: Transmission Pipe.....	62
<b>Section Four: Appendices</b>	
Appendix A: References.....	69
Appendix B: Reference Tables and Conversion Charts.....	70
Appendix C: Useful Formulas.....	75
Appendix D: Abbreviations.....	78
Appendix E: Tables and Figures.....	79

## NOTES

## OVERVIEW

IPEX is one of the largest manufacturers of plastic piping systems in North America. IPEX manufactures piping systems for many different applications, including:

- Sewer collection and transmission
- Water supply
- Electrical and communications systems
- Plumbing systems
- Industrial piping systems

This design manual covers the technical aspects of designing pressure pipe systems with PVC pipe. More specifically, municipal potable water systems, as well as irrigation and sewer force main systems are described.

The manual is organized into three sections:

Section 1 deals with specific products and includes detailed information on applications, dimensions and applicable standards for each system.

Section 2 deals with general design issues associated with PVC systems such as hydraulics, cyclic design and other topics that are applicable to all the products described in the manual.

Section 3 consists of design examples that apply the concepts from the first two sections.

This manual is designed for Engineers, Technologists and other municipal infrastructure professionals who require a deeper understanding of municipal piping systems than can be gleaned from the more general overview literature available from IPEX.



## NOTES

## SECTION 1: PRODUCT INFORMATION

### INTRODUCTION

IPEX offers a number of different pressure piping systems that are used for various applications. While they are all plastic systems, they vary in outside diameter configurations and in available pressure ratings.

The products offered are:

<b>Blue Brute® and IPEX Centurion® Piping Systems</b>	Cast-iron outside diameter (CIOD) pipe and fittings
<b>Bionax Pipe®</b>	Cast-iron outside diameter (CIOD)
<b>IPEX Fusible™</b>	Fusible Brute™ (CIOD) is available in sizes ranging from 100mm (4") to 750mm (30") while Fusible Series™ (IPS) pipe is available from 100mm (4") to 600mm (24").
<b>TerraBrute®CR Pipe</b>	CIOD pipe modified for use for trenchless installation methods such as directional drilling or pipe bursting or above-ground usage such as bridge crossings.
<b>CycleTough® Piping Systems</b>	Iron Pipe Size outside diameter (IPSOD) pipe and fittings
<b>Blue904® PEX Water Service Tubing</b>	3/4" through 2" PEX pipe designed for underground water service connections made to copper tube size (CTS) outside diameter.
<b>Gold901 Water Service Tubing</b>	3/4" - 2" High-Density Polyethylene (HDPE) pipe designed for use on both the municipal and private-side of a project.
<b>Q-Line® Water Service Tubing</b>	3/4" & 1" composite pipe designed for use underground water service connections, made to metric outside diameters.



## SUMMARY OF PRESSURE PIPE AND FITTINGS TESTING

All IPEX pressure pipes and fittings are manufactured to standards from various recognized organizations such as AWWA, CSA, ASTM and others. As a result, all pressure pipe products undergo a variety of testing and quality procedures.

### CIOD Pipe: Blue Brute, IPEX Centurion, Bionax, Fusible Brute and TerraBrute CR Piping Systems

These piping systems are manufactured under various AWWA standards, including AWWA C900 (Blue Brute, IPEX Centurion and TerraBrute CR), and C909 (Bionax). Fittings are manufactured C907 (molded) or C900 (fabricated standards).

Each length of Blue Brute, IPEX Centurion, Bionax and TerraBrute CR CIOD pipe is hydrostatically tested in order to verify the pressure capabilities of each pipe as dictated by AWWA C900 or C909. In addition, burst tests are carried out regularly to verify the integrity of the pipe and joint system. It should be remembered that the hydrostatic test is done using the pipe's own gasket, which means that both the pipe and the joining system are being checked. AWWA and CSA standards also require a number of other performance tests.

TerraBrute CR pipe does not strictly comply with AWWA C900 standard because of the dimensional change imposed by the grooving procedure, however it is tested using the same procedures as conventional Blue Brute and IPEX Centurion. The hydrostatic proof test is carried out on each length of TerraBrute CR to the same pressures and durations as for standard Blue Brute or IPEX Centurion.

In addition to Standard requirements, Certifications require very stringent testing and QA/QC procedures. For example, joint assemblies are regularly tested for full vacuum pressure .

The CSA Certification program also requires impact testing to be carried out at 0°C (32°F) to simulate more challenging cold weather conditions.

In addition to pressure and impact testing, finished PVC pipe is tested by using acetone immersion tests and heat reversion tests. Both tests are used to check that the proper degree of fusion has occurred during the extrusion process.

The dimensional characteristics of each pipe and fitting are checked constantly during the extrusion and molding processes, and samples are taken for detailed dimensional analysis during each extrusion or molding run.

### IPSOD Pipe: CycleTough and Fusible Series

CycleTough pipe undergoes testing identical to that of Blue Brute and IPEX Centurion pipe with the exception of the hydrostatic proof test of each length of pipe. This does not mean that the pipe is of any lesser quality than Blue Brute or IPEX Centurion pipe – it only means that it is manufactured under a different standard (ASTM D2241) that does not require the every-length hydrostatic proof test.

In addition to performance and dimensional checks, National Sanitation Foundation (NSF) requirements mean that all products are thoroughly tested to ensure they are suitable to convey potable water.

To summarize – There are many standards governing the manufacture and design of IPEX pressure pipes and fittings. IPEX also has internal testing standards that are often well in excess of published requirements to ensure acceptable performance on the jobsite.

## BLUE BRUTE® PIPING SYSTEMS

Blue Brute is one of the most well known names in municipal water supply, as it has built up an enviable reputation for performance and reliability over the years. Blue Brute pipe and fittings eliminate the threat of corrosion, while providing reliable long-term service. While Blue Brute pipe is compatible with iron fittings, IPEX recommends the use of Blue Brute fittings as they are made to match the pipe, and eliminate the “Achilles heel” of many systems – corroding iron fittings.

It is advisable to specify pipe and fittings from the same manufacturer in order to ensure a completely matched system. Only by specifying Blue Brute fittings can you ensure that the fittings have the same long term strength as the pipe itself.

### Applications:

Municipal water distribution systems and fire lines.  
Irrigation, sewage forcemains, industrial lines.

### Gasket Options For Contaminated Soils

Blue Brute pipe and fittings have removable gaskets. This allows oil resistant (nitrile) gaskets to be easily substituted when installing piping systems in contaminated soils. Please refer to Section 2 – Chemical Permeation and Resistance for more information on this topic.

### Standards:

#### Blue Brute Pipe:

AWWA C900, CSA B137.3 certified, FM 1612 approved, UL 1285 listed, NSF 61 certified, Certified to **NQ** 36240-250



#### Blue Brute Fittings:

AWWA C907, CSA B137.2 (100mm – 300mm) certified, AWWA C900, CSA B137.3 (250mm – 300mm) certified, FM 1612 approved, UL 1285 listed



## BLUE BRUTE® PIPING SYSTEMS

### Short Form Specifications

#### General

Blue Brute pipe shall be certified to CSA B137.3 “Rigid Polyvinyl Chloride PVC Pipe for Pressure Applications” and shall conform to AWWA C900 “Polyvinyl Chloride (PVC) Pressure Pipe, 4” – 60” for Water Transmission and Distribution.” Blue Brute DR25 pipe shall have a pressure class/rating of 1120 kPa (165 psi). DR18 pipe shall have a pressure class/rating of 1620 kPa (235 psi). DR14 pipe shall have a pressure class/rating of 2100 kPa (305 psi).

#### Material

Blue Brute pipe shall be made from PVC compound conforming to ASTM D1784 cell class 12454.

#### Product

Pipe shall be suitable for use at maximum hydrostatic working pressure equal to the pressure class/rating at 23°C (73°F). Laying lengths shall be 6.1 metres (20 feet). Pipe shall have cast-iron outside diameters. Each length of pipe must be proof-tested at two times the pressure class.

#### Joining

The gasket shall be carefully fitted to the bell groove if not already factory installed. Both bell and spigot shall be clean and free of debris before approved lubricant is

applied. The pipe and/or fittings shall be joined by pushing the spigot into the bell to the depth line marked on the spigot. When pipe has been cut in the field, the end shall be made square and beveled to a 15° chamfer. All insertion lines should be re-drawn, according to the IPEX Pressure Pipe Installation Guide.

#### Molded Fittings

Blue Brute fittings shall conform to AWWA C907 “Polyvinyl Chloride (PVC) Pressure Fittings for Water (4” through 12”)” and be certified to CSA B137.2 “PVC Injection Molded Gasketed Fittings for Pressure Applications.” They shall also be UL Listed and FM approved.

#### Fabricated Fittings

Fabricated fittings shall be made from segments of AWWA C900 PVC pipe. Segements are bonded together and may be over-wrapped with fibreglass-reinforced polyester. The pressure class must match the pipe. The fittings must meet the requirements of CSA B137.3.

#### Lubricant

Pipe must be assembled with IPEX non-toxic, water soluble lubricant listed by the National Sanitation Foundation.

### Dimensions:

Blue Brute pipes and fittings are manufactured with cast-iron outside diameters (CIOD), which means that they are compatible with much of the existing infrastructure of older iron pipes. This means that no special transition fittings are needed with Blue Brute.

Size		DR 25 Class 165 AWWA pressure class 165 psi CSA pressure rating 1,130 kPa						DR 18 Class 235 AWWA pressure class 235 psi CSA pressure rating 1,620 kPa						DR 14 Class 305 AWWA pressure class 305 psi CSA pressure rating 2,130 kPa					
		Avg. ID		Min. Wall Thickness		Avg. OD		Avg. ID		Min. Wall Thickness		Avg. OD		Avg. ID		Min. Wall Thickness		Avg. OD	
in	mm	in	mm	in	mm	in	mm	in	mm	in	mm	in	mm	in	mm	in	mm	in	mm
4	100	4.42	112	0.192	4.88	4.80	122	4.27	108	0.267	6.78	4.80	122	4.11	104	0.343	8.71	4.80	122
6	150	6.35	161	0.276	7.01	6.90	175	6.13	155	0.383	9.73	6.90	175	5.91	149	0.493	12.52	6.90	175
8	200	8.33	212	0.362	9.20	9.05	230	8.05	204	0.502	12.80	9.05	230	7.76	198	0.646	16.42	9.05	230
10	250	10.21	260	0.444	11.30	11.10	282	9.87	250	0.616	15.70	11.10	282	9.51	242	0.793	20.14	11.10	282
12	300	12.15	309	0.527	13.41	13.20	335	11.73	297	0.733	18.62	13.20	335	11.31	287	0.943	23.95	13.20	335

# BLUE BRUTE® PIPING SYSTEMS

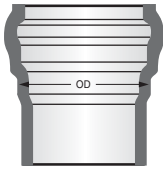

## Bell OD for Joint Restraint Selection

Size		Minimum		Maximum	
in	mm	in	mm	in	mm
4	100	5.44	138	5.61	142
6	150	7.84	199	8.03	204
8	200	10.29	261	10.55	268
10	250	12.63	322	12.96	329
12	300	15.07	383	15.46	393
14	350	17.28	439	17.73	450
16	400	19.64	448	20.17	512

\*Sizes 10" and 12" have external lugs to assist in pry-bar assemblies.

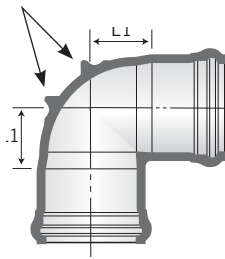

## 90° Elbow

Size		L1	
in	mm	in	mm
4	100	2.6	67
6	150	4.3	108
8	200	5.5	140
10	250	6.7	171
12	300	7.7	195

## 45° Elbow

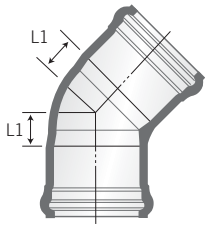

Size		L1	
in	mm	in	mm
4	100	1.3	33
6	150	1.8	46
8	200	2.2	56
10	250	2.7	70
12	300	3.2	82

## 22-1/2° Elbow

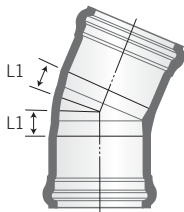

Size		L1	
in	mm	in	mm
6	150	1.0	25
8	200	1.1	28
10	250	1.7	43
12	300	1.9	48

## 11-1/4° Elbow

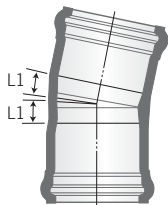

Size		L1	
in	mm	in	mm
4	100	3.0	75
6	150	0.8	20
8	200	0.9	23

Note: Other DR's and sizes up to 60" (1500mm) are available on request.

# BLUE BRUTE® PIPING SYSTEMS

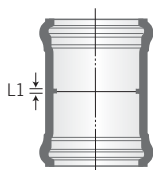
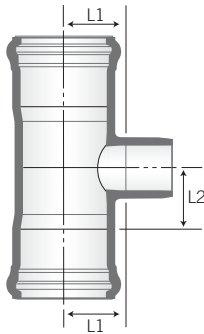
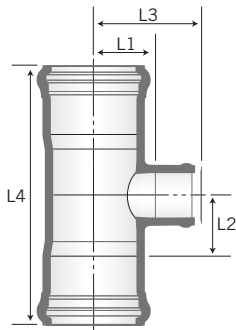
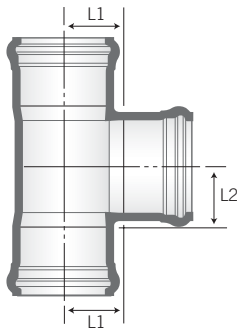

## Tee

Nominal Size		L1		L2		L3		L4	
in	mm	in	mm	in	mm	in	mm	in	mm
4 x 4 x 4	100 x 100 x 100	2.6	67	2.6	67	-	-	-	-
6 x 6 x 4	150 x 150 x 100	4.0	102	3.3	87	-	-	-	-
6 x 6 x 6	150 x 150 x 150	4.3	108	4.3	108	-	-	-	-
8 x 8 x 4	200 x 200 x 100	5.1	130	3.6	91	-	-	-	-
8 x 8 x 6	200 x 200 x 150	5.3	136	4.7	120	-	-	-	-
8 x 8 x 8	200 x 200 x 200	5.6	143	5.8	148	-	-	-	-
10 x 10 x 4	250 x 250 x 100	6.7	171	6.7	171	11.2	284	27.3	693
10 x 10 x 6	250 x 250 x 150	6.7	171	6.7	171	12.0	305	27.3	693
10 x 10 x 8	250 x 250 x 200	6.7	171	6.7	171	12.8	325	27.3	693
10 x 10 x 10	250 x 250 x 250	6.7	171	6.7	171	13.7	348	27.3	693
12 x 12 x 4	300 x 300 x 100	7.7	195	7.7	195	12.1	307	30.5	775
12 x 12 x 6	300 x 300 x 150	7.7	195	7.7	195	12.9	328	30.5	775
12 x 12 x 8	300 x 300 x 200	7.7	195	7.7	195	13.7	348	30.5	775
12 x 12 x 10	300 x 300 x 250	7.7	195	7.7	195	14.6	371	30.5	775
12 x 12 x 12	300 x 300 x 300	7.7	195	7.7	195	15.3	389	30.5	775

## Hammer Tee

Nominal Size		L1		L2		L3		L4	
in	mm	in	mm	in	mm	in	mm	in	mm
12 x 12 x 6	300 x 300 x 150	7.7	195	7.7	195	12.9	328	30.5	775

## Hydrant Tee

Nominal Size		L1		L2		L3		L4	
in	mm	in	mm	in	mm	in	mm	in	mm
6 x 6 x 6	150 x 150 x 150	4.5	114	3.8	96	11.5	292	17.0	457
8 x 8 x 6	200 x 200 x 150	5.8	148	5.2	132	12.8	312	22.4	569
10 x 10 x 6	250 x 250 x 150	7.0	178	6.7	171	14.0	356	27.3	693
12 x 12 x 6	300 x 300 x 150	8.1	206	7.7	195	15.1	384	30.5	775

## Reducing Adapter Spigot x Bell

Size		L1		L2	
in	mm	in	mm	in	mm
6 x 4	150 x 100	5.6	141	4.3	108
8 x 6	200 x 150	6.5	165	5.7	145
10 x 8	250 x 200	7.0	178	5.8	147
12 x 10	300 x 250	7.9	202	6.6	167

## Coupling (available w/o center stop as a Repair Coupling)

Size		L1	
in	mm	in	mm
4	100	0.2	5
6	150	0.3	8
8	200	0.3	7
10	250	0.5	13
12	300	0.5	13

## BLUE BRUTE® PIPING SYSTEMS

### Single Tapped Coupling

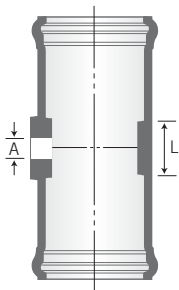

Size		A		L1	
in	mm	in	mm	in	mm
4 x 4 x 3/4	100 x 100 x 20	3/4	20	2	50
4 x 4 x 1	100 x 100 x 25	1	25	2	50
6 x 6 x 3/4	150 x 150 x 20	3/4	20	3	76
6 x 6 x 1	150 x 150 x 25	1	25	3	76
6 x 6 x 1-1/4	150 x 150 x 32	1-1/4	32	3	76
6 x 6 x 1-1/2	150 x 150 x 40	1-1/2	40	3	76
6 x 6 x 2	150 x 150 x 50	2	50	3	76
8 x 8 x 3/4	200 x 200 x 20	3/4	20	3	76
8 x 8 x 1	200 x 200 x 25	1	25	3	76
8 x 8 x 1-1/4	200 x 200 x 32	1-1/4	32	3	76
8 x 8 x 1-1/2	200 x 200 x 40	1-1/2	40	3	76
8 x 8 x 2	200 x 200 x 50	2	50	3	76
10 x 10 x 3/4	250 x 250 x 20	3/4	20	3	76
10 x 10 x 1	250 x 250 x 25	1	25	3	76
12 x 12 x 3/4	300 x 300 x 20	3/4	20	3	76
12 x 12 x 1	300 x 300 x 25	1	25	3	76

Note: 3/4" (20mm) Taps to 2" (50mm). Taps: AWWA Thread

### Double Tapped Coupling

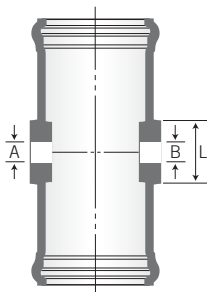

Size		A		B		L	
in	mm	in	mm	in	mm	in	mm
6 x 3/4 x 3/4	150 x 20 x 20	3/4	20	3/4	20	3	76
6 x 1 x 3/4	150 x 25 x 20	3/4	20	1	25	3	76
6 x 1 x 1	150 x 25 x 25	1	25	1	25	3	76
6 x 1-1/4 x 3/4	150 x 32 x 20	3/4	20	1-1/4	32	3	76
6 x 1-1/4 x 1	150 x 32 x 25	1	25	1-1/4	32	3	76
6 x 1-1/2 x 3/4	150 x 40 x 20	3/4	20	1-1/2	40	3	76
6 x 1-1/2 x 1	150 x 40 x 25	1	25	1-1/2	40	3	76
6 x 2 x 3/4	150 x 50 x 20	3/4	20	2	50	3	76
6 x 2 x 1	150 x 50 x 25	1	25	2	50	3	76
8 x 3/4 x 3/4	200 x 20 x 20	3/4	20	3/4	20	3	76
8 x 1 x 3/4	200 x 25 x 20	3/4	20	1	25	3	76
8 x 1 x 1	200 x 25 x 25	1	25	1	25	3	76
8 x 1-1/4 x 3/4	200 x 32 x 20	3/4	20	1-1/4	32	3	76
8 x 1-1/4 x 1	200 x 32 x 25	1	25	1-1/4	32	3	76
8 x 1-1/2 x 3/4	200 x 40 x 20	3/4	20	1-1/2	40	3	76
8 x 1-1/2 x 1	200 x 40 x 25	1	25	1-1/2	40	3	76
8 x 2 x 3/4	200 x 50 x 20	3/4	20	2	50	3	76
8 x 2 x 1	200 x 50 x 25	1	25	2	50	3	76

Note: 3/4" (20mm) Taps to 2" (50mm). Taps: AWWA Thread

# BLUE BRUTE® PIPING SYSTEMS

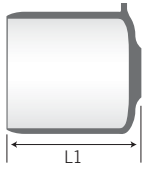

## Plug

Size		L1	
in	mm	in	mm
4	100	6.5	164
6	150	7.8	198
8	200	9.1	231
10	250	10.2	258
12	300	9.8	249

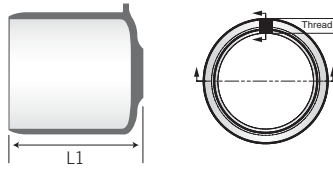

## Tapped Plug (IPS Threads)

Size		L1	
in	mm	in	mm
4 x 3/4	100 x 20	6.5	164
4 x 1	100 x 25	6.5	164
4 x 1-1/2	100 x 40	6.5	164
4 x 2	100 x 50	6.5	164
6 x 3/4	150 x 20	7.8	198
6 x 1	150 x 25	7.8	198
6 x 1-1/2	150 x 40	7.8	198
6 x 2	150 x 50	7.8	198
8 x 3/4	200 x 20	9.1	231
8 x 1	200 x 25	9.1	231
8 x 1-1/2	200 x 40	9.1	231
8 x 2	200 x 50	9.1	231

## BIONAX® PIPING SYSTEMS

Bionax PVCO pipe and Blue Brute PVC fittings eliminate corrosion and provide a reliable long-term piping system. Although Bionax is compatible with iron fittings, IPEX recommends the use of Blue Brute fittings since they result in an all-plastic system that prevents corroding iron fittings.

It is advisable to specify pipe and fittings from the same manufacturer to ensure a completely matched system. If Bionax pipe is specified with Blue Brute fittings, the pipe and fittings will provide matched pressure capacities.

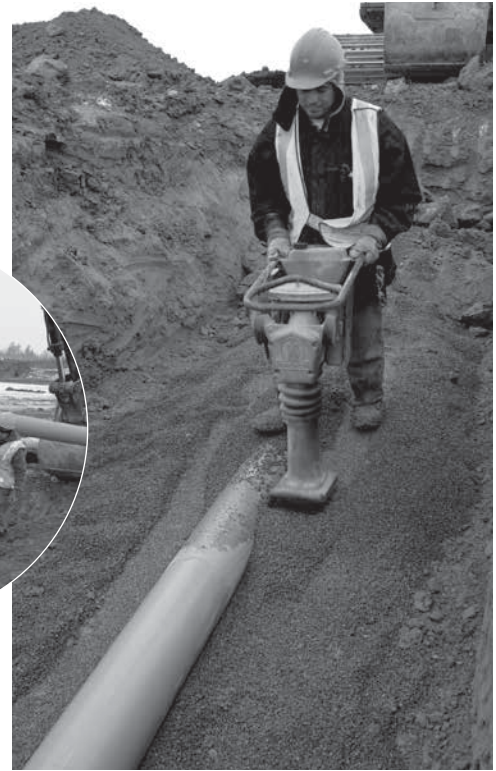

### Applications:

Municipal water distribution systems

Sewage forcemains\*, industrial process piping

### Pressure Class/Rating

Bionax CIOD pipe has a Pressure Rating (CSA) or a Pressure Class (AWWA) of 165 psi or 235 psi. Pressure Class 305 psi will soon be available.

### Surge Pressure Capacity

Bionax has tremendous ability to withstand short-term pressure surges. The short term ratings for Bionax are

PC 165 - 264psi

PC 235 - 376psi

PC 305 - 488psi

### Standards

Bionax pipe:

ANSI/NSF Standard 14, ANSI/NSF Standard 61

ASTM D3139, F477 and F1483

NSF-certified to AWWA C909 and ASTM F1483,

CSA-certified to B137.3.1 and FM-approved to FM1612.



\* White Bionax PVCO pipe for sewage forcemains



## BIONAX® PIPING SYSTEMS

### Short Form Specifications

#### General

Bionax CIOD pipe shall be certified to AWWA C909 “Molecularly Oriented Polyvinyl Chloride (PVCO) Pressure Pipe 4 inch and larger for Water, Wastewater, and Reclaimed Water Service” and certified to CSA B137.3.1 “Molecularly oriented polyvinylchloride (PVCO) pipe for pressure applications.” Bionax shall have a pressure class (AWWA) or pressure rating (CSA) of 165 psi or 235 psi.

#### Material

PVCO pipe shall be manufactured from rigid polyvinyl chloride (PVC) compound meeting the requirements of ASTM D1784 cell class 12454.

Gaskets shall meet ASTM F477 for high-head applications.

#### Product

Finished PVCO pipe shall have an HDB of 7100 psi. Laying lengths shall be 6.1 meters (20 feet). Pipe shall have cast-iron outside diameters. Every length must be proof-tested at two times the pressure class.

#### Fittings

Bionax piping systems shall include IPEX Blue Brute molded and fabricated fittings.

#### Lubricant

Pipe must be assembled with IPEX water-soluble lubricant listed to NSF Standard 61.

#### Color Coding

CIOD pipe shall be color coded blue.

#### Joining

The gasket shall be carefully fitted to the bell groove if not already factory-installed. Both bell and spigot shall be clean and free of debris before lubricant is applied. The pipe shall be joined by push-fitting bell and spigot joint to the depth line marked on the spigot. When pipe has been cut in the field, the end shall be made square and bevelled to a 10-degree chamfer and the insertion line shall be redrawn per IPEX's Pressure Pipe Installation Guide.

### Dimensions of Bionax PVCO Pressure Pipes with CIODs

Size		Pressure Class/Rating 165 psi @ 73°F (1,135 kPa @ 23°C)					
		Average OD		Min Wall Thickness		Average ID	
in	mm	in	mm	in	mm	in	mm
14	350	15.3	389	0.4	8.8	14.8	370
16	400	17.4	442	0.4	10.0	16.8	421
18	450	19.5	495	0.4	11.3	18.5	471
20	500	21.6	549	0.5	12.7	20.6	523
24	600	25.8	655	0.6	14.9	24.5	623
30	750	32.0	813	0.7	18.4	30.4	773

Size		Pressure Class/Rating 235 psi @ 73°F (1,620 kPa @ 23°C)					
		Average OD		Min Wall Thickness		Average ID	
in	mm	in	mm	in	mm	in	mm
4	100	4.8	122	0.2	3.9	4.5	114
6	150	6.9	175	0.2	5.6	6.4	164
8	200	9.1	230	0.3	7.34	8.5	215
10	250	11.1	282	0.4	9.0	10.4	263
12	300	13.2	335	0.4	10.7	12.3	313
14	350	15.3	389	0.5	12.5	14.3	364
16	400	17.4	442	0.6	14.7	16.3	414
18	450	19.5	495	0.6	15.9	18.2	463
20	500	21.6	549	0.7	17.6	20.7	512
24	600	25.8	655	0.8	21.0	24.0	610
30	750	32.0	813	1.0	26.0	29.8	758

Size		Pressure Class/Rating 305 psi @ 73°F (2,100 kPa @ 23°C)					
		Average OD		Min Wall Thickness		Average ID	
in	mm	in	mm	in	mm	in	mm
14	350	15.3	389	0.4	8.8	14.0	354
16	400	17.4	442	0.4	10.0	15.9	403
18	450	19.5	495	0.4	11.3	17.8	452
20	500	21.6	549	0.9	22.6	19.7	501
24	600	25.8	655	1.1	27.0	23.5	598
30	750	32.0	813	1.3	33.4	29.2	742

## WHITE BIONAX® PVCO PIPE

### Short Form Specifications

#### General

White Bionax CIOD pipe shall be certified to AWWA C909 "Molecularly Oriented Polyvinyl Chloride (PVCO) Pressure Pipe 4 inch and larger for Water, Wastewater, and Reclaimed Water Service" and certified to CSA B137.3.1 "Molecularly oriented polyvinylchloride (PVCO) pipe for pressure applications." Bionax shall have a pressure class (AWWA) or pressure rating (CSA) of 165 psi or 235 psi.

#### Material

PVCO pipe shall be manufactured from rigid polyvinyl chloride (PVC) compound meeting the requirements of ASTM D1784 cell class 12454.

Gaskets shall meet ASTM F477 for high-head applications.

#### Product

Finished PVCO pipe shall have an HDB of 7100 psi. Laying lengths shall be 6.1 meters (20 feet). Pipe shall have cast-iron outside diameters. Every length must be proof-tested at two times the pressure class.

#### Fittings

Bionax piping systems shall include IPEX Blue Brute molded and fabricated fittings.

#### Color Coding

CIOD pipe shall be color coded white.

#### Print Line

"SEWER PRESSURE/ NON-POTABLE" shall be printed on white Bionax pipe for easy differentiation from a water pressure pipe.

#### Joining

The gasket shall be carefully fitted to the bell groove if not already factory-installed. Both bell and spigot shall be clean and free of debris before lubricant is applied. The pipe shall be joined by push-fitting bell and spigot joint to the depth line marked on the spigot. When pipe has been cut in the field, the end shall be made square and bevelled to a 10-degree chamfer and the insertion line shall be redrawn per IPEX's Pressure Pipe Installation Guide.

### Dimensions of White Bionax PVCO Pressure Pipes with CIODs

Size		Pressure Class/Rating 165 psi @ 73°F (1,135 kPa @ 23°C)					
		Average OD		Min Wall Thickness		Average ID	
in	mm	in	mm	in	mm	in	mm
16	400	17.4	442	0.4	10.0	16.8	421
18	450	19.5	495	0.4	11.3	18.5	471

Size		Pressure Class/Rating 235 psi @ 73°F (1,620 kPa @ 23°C)					
		Average OD		Min Wall Thickness		Average ID	
in	mm	in	mm	in	mm	in	mm
6	150	6.9	175	0.2	5.6	6.4	164
8	200	9.1	230	0.3	7.34	8.5	215
10	250	11.1	282	0.4	9.0	10.4	263
12	300	13.2	335	0.4	10.7	12.3	313
14	350	15.3	389	0.5	12.5	14.3	364
16	400	17.4	442	0.6	14.7	16.3	414
18	450	19.5	495	0.6	15.9	18.2	463

## IPEX CENTURION® PIPING SYSTEMS

IPEX Centurion extends the benefits of Blue Brute to larger diameters of pipe and new applications. The versatility and ease of installation of IPEX Centurion is unmatched – and costly and difficult to install corrosion protection is eliminated. In addition, unlike HDPE or concrete pressure pipe, every length of IPEX Centurion is tested to double its pressure rating.

### Applications:

Water transmission lines, forcemains.  
Irrigation, gravity lines, industrial lines

### Standards:

AWWA C900, CSA B137.3, BNQ 3624-250, NSF 61

#### Factory Mutual FM 1612:

DR18 is FM approved to 24" (600mm diameter)

#### Underwriter's Laboratories UL 1285:

DR18 is listed to 24" (600mm diameter)

DR25 is listed to 30" (750mm diameter)

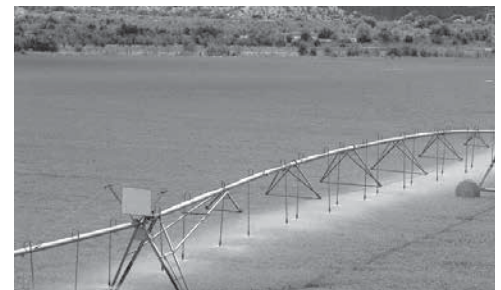
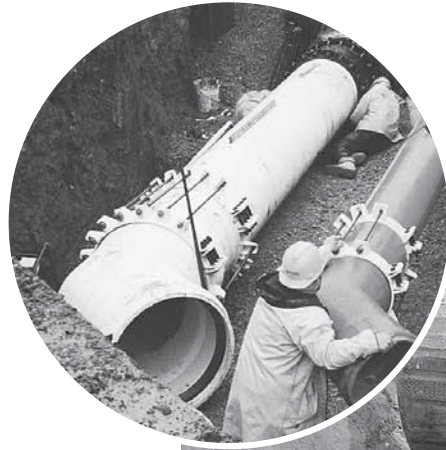

## IPEX CENTURION® PIPING SYSTEMS

### Short Form Specifications

#### General

Pipe must conform to AWWA C900 and be certified to CSA B137.3 "Rigid polyvinyl chloride (PVC) pipe for pressure applications." DR51, 41, 32.5, 25, 18, and 14 pipe must have the following pressure/class ratings: 80 psi (550 kPa), 100 psi (690 kPa), 125 psi (860 kPa), 165 psi (1,140 kPa), 235 psi (1,620 kPa) and 305 psi (2,100 kPa). For pressure applications, each length of pipe must be hydro-tested at twice the rating and a short-term pressure test must be conducted once per production run. Pipe to be IPEX Centurion or approved equal.

#### Fabricated Fittings

Fabricated fittings shall be made from segments of AWWA C900 pipe that are butt-fused or bonded together. Some fittings are over-wrapped with fiberglass-reinforced polyester. The fittings must always meet or exceed the pressure/class rating of the pipe system.

#### Color Coding

Water pipe and fittings shall be color coded blue.

#### Pressure Ratings

IPEX Centurion can withstand extremely high short term pressures, in addition to lower levels of long-term pressure. As a result, AWWA C900 standard includes both long term pressure ratings (LTR) and short term ratings (STR).

DR	Short Term Rating		Long Term Rating	
	psi	kPa	psi	kPa
51	128	880	80	550
41	160	100	100	690
32.5	200	1,380	125	860
25	264	1,820	165	1,140
18	376	2,590	235	1,620
14	488	3,370	305	2,100

#### Surge Pressures

Transient pressures in pipelines occur as a result of the fluid velocity changing over a relatively short time. The method for approximating a surge pressure is described in section 2. However it should be noted that for most large diameter pipelines, a formal transient analysis should be carried out by a qualified person in order to fully understand the effects of transients in any given system. The method shown in section 2 is certainly appropriate for initial design purposes however.

The table below shows the surge pressure generated assuming an instantaneous stoppage of a flow moving at 0.3 m/s (1 ft/s).

DR	Surge Pressure	
	psi	kPa
51	10.8	75
41	11.4	79
32.5	12.8	88
25	14.7	101
18	17.4	120
14	19.8	137
Bionax (PC235)	14.1	97

# IPEX CENTURION® PIPING SYSTEMS

## IPEX Centurion for Gravity Applications

With its pressure rated joints and non-corroding construction, IPEX Centurion is a natural choice for gravity flow lines. When designing any flexible conduit application, the ring deflection should be calculated for the applicable loading conditions. The table below shows the ring deflections for a variety of different DRs based on depth of bury and H<sub>2</sub>O loading. For more information on how to calculate ring deflections for PVC pipe, please refer to the IPEX Sewer Design Manual.

1. Deflection values shown include effect of H<sub>2</sub>O live load and dead load.
2. External loading based upon a prism load of soil weight of 120 lbs. per cubic foot (1 900 kg/m<sup>3</sup>).
3. Bedding classifications correspond to ASTM D2321.
4. The deflection lag factor is 1.0 for a prism load.
5. DR18 & DR 14 deflections have not been shown because they are insignificant in most cases.
6. Recommended maximum deflection is 7.5%.  
Contact IPEX for applications where greater deflections are anticipated.
7. n/r - not recommended for H<sub>2</sub>O live load \ (ok with dead load)

**Table 1 – Percent (%) Deflection for IPEX Centurion Pressure Pipe**

ASTM EMBEDMENT MATERIAL CLASSIFICATION		DENSITY (PROCTOR) AASHTO T-99	E' psi (kPa)	DR	DEPTH OF COVER																
					ft	1	2	4	6	8	10	15	20	25	30	35	40	45	50		
					m	0.3	0.6	1.2	1.8	2.4	3.0	4.6	6.1	7.6	9.1	10.7	12.2	13.7	15.2		
Manufactured Granular Angular	CLASS I	90%	3,000 (20 700)	51	n/r	0.5	0.3	0.4	0.4	0.5	0.7	0.9	1.1	1.4	1.6	1.8	2.0	2.3			
				41	n/r	0.5	0.3	0.4	0.4	0.4	0.7	0.9	1.1	1.3	1.6	1.8	2.0	2.2			
				32.5	0.7	0.5	0.3	0.3	0.4	0.4	0.7	0.9	1.1	1.3	1.5	1.7	2.0	2.2			
				25	0.7	0.5	0.3	0.3	0.4	0.4	0.6	0.8	1.0	1.2	1.4	1.6	1.9	2.1			
Clean Sand & Gravel	CLASS II	90%	2,000 (13 000)	51	n/r	0.7	0.5	0.5	0.6	0.7	1.0	1.3	1.7	2.0	2.3	2.7	3.0	3.4			
				41	n/r	0.7	0.5	0.5	0.6	0.7	1.0	1.3	1.7	2.0	2.3	2.6	3.0	3.3			
				32.5	1.0	0.7	0.5	0.5	0.6	1.0	1.3	1.6	1.9	2.2	2.6	2.9	3.2				
				25	1.0	0.7	0.4	0.5	0.5	0.6	0.9	1.2	1.5	1.8	2.1	2.4	2.7	2.9			
			80%	1,000 (7 000)	51	n/r	1.5	1.0	1.1	1.1	1.3	2.0	2.6	3.3	4.0	4.6	5.3	5.9	6.6		
					41	n/r	1.4	1.0	1.1	1.3	1.9	2.6	3.2	3.8	4.5	5.1	5.8	6.4			
					32.5	2.0	1.3	0.9	1.0	1.0	1.2	1.8	2.4	3.0	3.6	4.2	4.8	5.4	6.0		
					25	1.7	1.1	0.8	0.8	0.9	1.0	1.6	2.1	2.6	3.1	3.6	4.2	4.7	5.2		
Sand & Gravel with Fines	CLASS III	90%	1,000 (7 000)	51	n/r	1.5	1.0	1.1	1.1	1.3	2.0	2.6	3.3	4.0	4.6	5.3	5.9	6.6			
				41	n/r	1.4	1.0	1.1	1.3	1.9	2.6	3.2	3.8	4.5	5.1	5.8	6.4				
				32.5	2.0	1.3	0.9	1.0	1.0	1.2	1.8	2.4	3.0	3.6	4.2	4.8	5.4	6.0			
				25	1.7	1.1	0.8	0.8	0.9	1.0	1.6	2.1	2.6	3.1	3.6	4.2	4.7	5.2			
			85%	500 (3 500)	51	n/r	n/r	1.9	2.0	2.2	2.6	3.8	5.1	6.4	7.7	8.9	10.2	11.5	12.8		
					41	n/r	n/r	1.8	1.9	2.1	2.4	3.6	4.8	6.0	7.2	8.4	9.6	10.8	12.0		
					32.5	n/r	2.4	1.6	1.7	1.8	2.1	3.2	4.3	5.3	6.4	7.5	8.5	9.6	10.7		
					25	n/r	1.9	1.3	1.3	1.4	1.7	2.5	3.3	4.2	5.0	5.9	6.7	7.5	8.4		
Silt & Clay	CLASS IV	85%	400 (2 760)	51	n/r	n/r	2.4	2.5	2.7	3.1	4.7	6.3	7.9	9.4	11.0	12.6	14.1	15.7			
				41	n/r	n/r	2.2	2.3	2.5	2.9	4.4	5.8	7.3	8.8	10.2	11.7	13.1	14.6			
				32.5	n/r	2.8	1.9	2.0	2.2	2.5	3.8	5.1	6.3	7.6	8.9	10.1	11.4	12.7			
				25	n/r	2.1	1.4	1.5	1.6	1.9	2.9	3.8	4.8	5.7	6.7	7.6	8.6	9.5			

## IPEX CENTURION® PIPING SYSTEMS

### Dimensions

IPEX Centurion is manufactured with a cast-iron outside diameter (CIOD) so it is compatible with much of the existing older infrastructure of iron pipes. In addition, IPEX Centurion can be field-cut, which means unexpected changes in the field can be accommodated quickly, without having to wait for new shop drawings.

IPEX Centurion Fittings are manufactured using sections of AWWA C900 pipe that are fused or bonded together. Some fittings are overwrapped with a layer of fibre reinforced plastic (FRP). While IPEX Centurion is compatible with iron fittings, IPEX recommends the use of IPEX Centurion fittings exclusively with IPEX Centurion pipe.

		PR/PC 80 (SDR51)						PR/PC 100 (SDR41)						PR/PC 125 (SDR32.5)					
Size		Avg. ID		Min. Wall Thickness		Avg. OD		Avg. ID		Min. Wall Thickness		Avg. OD		Avg. ID		Min. Wall Thickness		Avg. OD	
in	mm	in	mm	in	mm	in	mm	in	mm	in	mm	in	mm	in	mm	in	mm	in	mm
14	350	-	-	-	-	15.3	388.6	14.6	369.7	0.37	9.5	15.3	388.6	14.4	364.7	0.47	12.0	15.3	388.6
16	400	16.7	423.7	0.36	9.19	17.4	442.0	16.6	420.4	0.43	10.8	17.4	442.0	16.3	414.5	0.54	13.6	17.4	442.0
18	450	18.7	475.9	0.38	9.71	19.5	495.3	18.5	471.1	0.48	12.1	19.5	495.3	18.3	464.8	0.60	15.2	19.5	495.3
20	500	20.8	527.0	0.42	10.80	21.6	548.6	20.5	521.8	0.53	13.4	21.6	548.6	20.3	514.6	0.67	16.9	21.6	548.6
24	600	24.8	629.6	0.50	12.90	25.8	655.3	24.5	623.3	0.63	16.0	25.8	655.3	24.2	615.0	0.80	20.2	25.8	655.3
30	750	30.7	780.9	0.63	15.93	32.0	812.8	30.4	773.2	0.78	19.8	32.0	812.8	30.0	762.8	0.98	25.0	32.0	812.8
36	900	36.8	934.7	0.75	19.10	38.3	972.8	36.4	925.3	0.93	23.7	38.3	972.8	35.9	912.9	1.18	29.9	38.3	972.8
42	1050	42.6	1082.8	0.87	22.20	44.5	1130.3	42.2	1071.4	1.09	27.5	44.5	1130.3	41.6	1056.6	1.37	34.8	44.5	1130.3
48	1200	48.7	1236.2	1.00	25.30	50.8	1290.3	48.2	1223.0	1.24	31.5	50.8	1290.3	47.4	1211.1	1.56	39.6	50.8	1290.3
54	1350	55.3	1404.6	1.13	28.7	57.6	1462.0	54.8	1391.9	1.40	35.7	57.6	1462.0	54.1	1374.1	1.77	45.0	57.6	1462.0
60	1500	59.2	1503.2	1.21	30.7	61.6	1564.9	58.6	1488.4	1.50	38.1	61.6	1564.9	-	-	-	-	-	-

		PR/PC 165 (DR25)						PR/PC 235 (DR18)						PR/PC 305 (DR14)					
Size		Avg. ID		Min. Wall Thickness		Avg. OD		Avg. ID		Min. Wall Thickness		Avg. OD		Avg. ID		Min. Wall Thickness		Avg. OD	
in	mm	in	mm	in	mm	in	mm	in	mm	in	mm	in	mm	in	mm	in	mm	in	mm
14	350	14.1	357.5	0.61	15.60	15.3	388.6	13.6	345.4	0.85	21.6	15.3	388.6	13.1	333.0	1.09	27.8	15.3	388.6
16	400	16.0	406.6	0.70	17.70	17.4	442.0	15.5	392.9	0.97	24.6	17.4	442.0	14.9	378.8	1.24	31.6	17.4	442.0
18	450	17.9	455.7	0.78	19.81	19.5	495.3	17.3	440.3	1.08	27.5	19.5	495.3	-	-	-	-	-	-
20	500	19.9	504.7	0.86	22.00	21.6	548.6	19.2	487.6	1.20	30.5	21.6	548.6	-	-	-	-	-	-
24	600	23.7	602.9	1.03	26.21	25.8	655.3	22.9	582.5	1.43	36.4	25.8	655.3	-	-	-	-	-	-
30	750	29.4	747.8	1.28	32.51	32.0	812.8	28.4	722.4	1.78	45.2	32.0	812.8	-	-	-	-	-	-
36	900	35.2	895.0	1.53	38.91	38.3	972.8	34.0*	863.6*	2.13*	54.1*	38.3*	972.8*	-	-	-	-	-	-
42	1050	40.9*	1039.9*	1.78*	45.2*	44.5*	1130.3*	39.6*	1004.8*	2.47*	62.8*	44.5*	1130.3*	-	-	-	-	-	-
48	1200	46.7*	1187.2*	2.03*	51.6*	50.8	1290.3*	-	-	-	-	-	-	-	-	-	-	-	-
54	1350	-	-	-	-	-	-	-	-	-	-	-	-	-	-	-	-	-	-
60	1500	-	-	-	-	-	-	-	-	-	-	-	-	-	-	-	-	-	-

\* Coming Soon

## IPEX FUSIBLE™ PVC PIPE FOR TRENCHLESS APPLICATIONS

By combining the mechanical properties of PVC with an innovative, patented butt fusion process, IPEX provides the only available method of installing a continuous, monolithic, fully restrained PVC pipe system. Capable of being used in a variety of trenchless or conventional direct bury applications, Fusible PVC™ pipe systems have been installed at numerous sites throughout the United States, Canada and Mexico for both pressure and non-pressure installations in the water and sewer industries.

Fusible Brute (CIOD) and Fusible Series (IPS) pipes are available in sizes ranging from 100mm (4") to 750mm (30") with larger sizes in development. The proprietary PVC formulation, fusion process as well as our licensing and training program allow for the consistent, reliable fusion of Fusible Brute and Fusible Series pipes to create piping systems of unparalleled strength.



### Applications:

Water mains, sanitary sewers, process and raw water, reclaimed water and storm drains.

### Installations:

- Slip Lining
- Pipe Bursting
- Direct Bury
- Horizontal Directional Drilling

### Standards:

**AWWA** C900, **CSA** B137.3, **NSF** 61 and **ASTM** cell classification 12454.

Pipe used in IPEX Fusible Brute™ and Fusible Series™ product lines Certified to **CSA** B137.3.

IPEX Fusible Brute™ products meet the **AWWA** C900 standard.

IPEX Fusible Brute™ and Fusible Series™ products are marked with **NSF** 61 when used for potable service.



## IPEX FUSIBLE™ PVC PIPE FOR TRENCHLESS APPLICATIONS

### Short Form Specifications

#### Fusible PVC Pipe

IPEX pipe used in Fusible applications is certified to CSA B137.3 and NSF61, and conforms to AWWA C900. Testing shall be in accordance with CSA B137.3 and AWWA standards for all pipe types.

#### Fusion Technician Requirements

The PVC Fusion contractor must be identified in the tender documents and the Fusion Technician shall be fully qualified by IPEX to fuse Fusible PVC pipe of the type(s) and size(s) being used. Qualification shall be current as of the actual date of the tender and of fusion on the project.

### Minimum Bend Radius

Minimum bend radii are independent of DR.

Bend Radius calculations are based on the assumption that a fitting or flange is present/to be installed in the bend. The Bend Radius for PVC includes a safety factor of 2.5 [Unibell Handbook of PVC, 4th Edition, Equation 8.6].

Pipe Size		Bend Radius	
inches	mm	ft	m
4	100	328	30.5
6	150	492	43.7
8	200	656	57.5
10	250	820	70.4
12	300	984	83.7
14	350	1148	97.1
16	400	1312	110.4

### Critical Buckling Pressure & Grout Pressure

- Initiates deformation of pipe through external pressure
- Important to backfilling and grouting
- Maximum recommended pressure:

DR	Critical Buckling Pressure	Grout Pressure
	psi	psi
14	426	213
18	190	85
25	67	33.5
32.5	27	13.5
41	14.6	7.3
51	7.4	3.7

### Effect of Temperature

Temperature		Pressure Rating Factor	Tensile Factor (Pull Force)	Modulus of Elasticity Factor (Bend Radius)
°F	°C	%	%	%
73.4	23	100	100	100
80	26.7	88	95	98
90	32.2	75	87	94
100	37.8	62	78	88
120	48.9	40	63	78
140	60	22	58	70

Critical Buckling Pressures are calculated using a Long Term Modulus of Elasticity (400,000 PSI for PVC), and published Poisson's Ratio [Unibell Handbook of PVC, 4th Edition, equation 7.13]. No safety factor is included in the calculation for Critical Buckling Pressures.

Note: These maximum pressures are based on the temperature in the wall of the pipe not exceeding 73°F (23°C)

Maximum grouting pressures must be reduced with increased wall temperatures.

See the *IPEX Pressure Pipe Installation Guide* for more details.



# IPEX FUSIBLE™ PVC PIPE FOR TRENCHLESS APPLICATIONS

## IPEX Fusible Brute Pipe Data CIOD

Nominal Size		DR	Avg. O.D.	Min. Wall	Avg. I.D.	Safe Pulling Force	Pressure Rating	Critical Buckling Pressure	Min. Allowable Bend Radius
(in)	(mm)		(mm)	(mm)	(mm)	(lbf)	(psi)	(psi)	(m)
4	100	14	122.0	8.7	104.0	13,877	305	426	30.5
6	150	14	175.0	12.5	149.0	28,736	305	426	43.7
8	200	14	230.0	16.4	198.0	46,720	305	426	57.5
10	250	14	282.0	20.1	242.0	71,499	305	426	70.4
12	300	14	335.0	24.0	287.0	101,846	305	426	83.7
4	100	18	122.0	6.8	108.0	10,984	235	190	30.5
6	150	18	175.0	9.7	155.0	22,514	235	190	43.7
8	200	18	230.0	12.8	204.0	38,492	235	190	57.5
10	250	18	282.0	15.7	250.0	58,073	235	190	70.4
12	300	18	335.0	18.6	297.0	81,924	235	190	83.7
14	350	18	388.6	21.6	345.4	108,166	235	190	97.1
16	400	18	442.0	24.6	392.9	139,838	235	190	110.4
18	450	18	495.3	27.5	440.3	175,535	235	190	123.7
20	500	18	548.6	30.5	487.6	215,617	235	190	137.1
24	600	18	655.3	36.4	582.5	307,392	235	190	163.7
4	100	25	122.0	4.9	112.0	7,982	165	67	30.5
6	150	25	175.0	7.0	161.0	15,518	165	67	43.7
8	200	25	230.0	9.2	212.0	26,616	165	67	57.5
10	250	25	282.0	11.3	260.0	40,438	165	67	70.4
12	300	25	335.0	13.4	309.0	57,247	165	67	83.7
14	350	25	388.6	15.6	357.5	77,491	165	67	97.1
16	400	25	442.0	17.7	406.6	99,719	165	67	110.4
18	450	25	495.3	19.8	455.7	125,284	165	67	123.7
20	500	25	548.6	22.0	504.7	153,768	165	67	137.1
24	600	25	655.3	26.2	602.9	218,545	165	67	163.7
30	750	25	812.8	32.5	747.8	335,507	165	67	203.1
36	900	25	972.8	38.9	895.0	480,557	165	67	243.0
20	500	32.5	548.6	16.9	512.8	118,256	125	30	137.1
24	600	32.5	655.3	20.2	615.0	168,551	125	30	163.7

# IPEX FUSIBLE™ PVC PIPE FOR TRENCHLESS APPLICATIONS

## IPEX Fusible Series Pipe Data IPS

Nominal Size		DR	Avg. O.D.	Min. Wall	Avg. I.D.	Safe Pulling Force	Pressure Rating	Critical Buckling Pressure	Min. Allowable Bend Radius
(in)	(mm)		(mm)	(mm)	(mm)	(lbf)	(psi)	(psi)	(m)
4	100	21	114.3	5.4	102.8	7,783	200	117	28.6
6	150	21	168.3	8.0	151.3	16,931	200	117	42.0
8	200	21	219.1	10.4	197.0	28,612	200	117	54.7
10	250	21	273.1	13.0	245.5	44,887	200	117	68.2
12	300	21	323.9	15.4	291.3	63,280	200	117	80.9
14	350	21	355.6	16.9	319.8	76,343	200	117	88.8
16	400	21	406.4	19.4	365.3	99,895	200	117	101.5
18	450	21	457.2	21.8	411.0	126,646	200	117	114.2
20	500	21	508.0	24.2	456.7	155,897	200	117	126.9
24	600	21	609.6	29.0	548.1	223,407	200	117	152.3
4	100	26	114.3	4.4	105.0	6,255	160	60	28.6
6	150	26	168.3	6.5	154.6	13,694	160	60	42.0
8	200	26	219.1	8.4	201.2	23,166	160	60	54.7
10	250	26	273.1	10.5	250.8	36,328	160	60	68.2
12	300	26	323.9	12.4	297.6	51,146	160	60	80.9
14	350	26	355.6	13.7	326.6	62,091	160	60	88.8
16	400	26	406.4	15.6	373.3	80,612	160	60	101.5
18	450	26	457.2	17.6	419.9	102,675	160	60	114.2
20	500	26	508.0	19.6	466.5	126,725	160	60	126.9
24	600	26	609.6	23.5	559.78	181,538	160	60	152.3

### Notes:

- 1 PVC safe pull stress of 7,000 psi is based on the published value of 7,000–8,000 PSI for short term tensile strength and a safety factor of 2.5 [Unibell Handbook of PVC, 4th Edition].
- 2 PVC safe pull forces are based on minimum wall thickness and the safe pull stresses as calculated per Note 1.
- 3 Critical Buckling Pressures are calculated using a Long Term Modulus of Elasticity (400,000 PSI for PVC), and published Poisson's Ratio [Unibell Handbook of PVC, 4th Edition, equation 7.13]. No safety factor is included in the calculation for Critical Buckling Pressures.
- 4 Pressure Ratings are per AWWA C900, AWWA C900 at 73° F.
- 5 Bend Radius calculations are based on the assumption that a fitting or flange is present/to be installed in the bend. The Bend Radius for PVC includes a safety factor of 2.5 [Unibell Handbook of PVC, 4th Edition, Equation 8.6].

## TERRABRUTE® CR RESTRAINED JOINT PIPE

TerraBrute CR is a modified AWWA C900 pipe that has been specifically designed for use with trenchless installation techniques like horizontal directional drilling (HDD) and pipe bursting. Using an innovative system of rings and pins, TerraBrute CR can withstand higher pull forces than any other mechanically restrained plastic piping system, while simultaneously being able to bend and flex in a borehole.

In addition to trenchless installations, TerraBrute CR's versatile joint is perfect for above ground installations like bridge crossings where there may be significant temperature extremes. Where other piping systems require costly and maintenance intensive expansion joints, the wide groove in each TerraBrute CR joint allows expansion and contraction of each pipe.

Another key attribute of the TerraBrute CR joint is that it allows pipe rotation without damage. This can be an issue in seismic zones where piping systems are subjected to a wide variety of soil induced stresses during earthquake events.

### External Pressures

Drilling fluids are used under many different soil conditions both to keep the borehole open and to remove the spoil from drilling and reaming operations. This drilling fluid is pressurized, and as a result, it is important that a pipe joint be able to withstand these external pressures without leaking fluid into the pipe string. IPEX has tested fully deflected joints to well over 100 psi external pressure with zero leakage.

### Applications:

HDD, pipe bursting, bridge crossings, seismic zones, casing installations and steep slopes.

### Standards

#### AWWA C900

TerraBrute CR is made with pipe conforming to AWWA C900. However once the pipe is grooved on the spigot end its dimensions do not match those published in the C900 standard. Because of this small dimensional difference the pipe, once grooved, does not strictly conform to the C900 standard. It is important to note however, that TerraBrute CR is subjected to the same testing program as IPEX's Blue Brute (C900) pipe.

#### CSA B137.3

TerraBrute CR is certified to **CSA B137.3**.

#### NQ 3624-250

### Factory Mutual and Underwriter's Laboratories

TerraBrute CR is made from starting stock that is **Factory Mutual** approved, and **ULC** and **ULI** listed.



## TERRABRUTE® CR RESTRAINED JOINT PIPE

### Short Form Specifications

PVC pipe used for horizontal directional drilling (HDD) or other trenchless installation methods shall be manufactured with a cast iron outside diameter (CIOD) and shall be made with starting stock certified to CSA B137.3 for 100mm - 300mm (4" - 12") diameters. Pipe will meet the requirements of AWWA C900, must be Factory Mutual approved, and listed by ULC or UL.

The maximum allowable pulling force shall be the ultimate tensile capacity of the piping system divided by a safety factor of 2, as shown in the adjacent table.

PVC pipe must be manufactured with an integral bell, and must have removable gaskets to allow the use of oil-resistant (nitrile) gaskets in contaminated soils.

Nominal Size		Maximum Allowable Pulling Force	
mm	Inches	kN	Lbs.
100	4	50	11200
150	6	110	24700
200	8	115	25800
250	10	187	42100
300	12	275	61800

### Dimensions

TerraBrute CR is virtually identical to Blue Brute dimensionally. It has a slightly shorter laying length, as a result of the extended bell, as well as a groove cut into the spigot end of the pipe.

One key dimension that must be remembered when planning pre-ream operations is the absolute maximum outside diameter of the pipe. The table below shows the maximum outside diameter of each size.

Due to the extended bell configuration, TerraBrute CR has slightly shorter laying length than standard Blue Brute pipe:

Nominal Size		Maximum Outside Diameter (Outside Ring)	
mm	Inches	mm	Inches
100	4	160	6.3
150	6	230	9.1
200	8	290	11.4
250	10	350	14.2
300	12	415	16.3

Nominal Size		Laying Lengths	
mm	Inches	m	Feet/Inches
100	4	6.04	19' 10"
150	6	6.03	19' 9"
200	8	6.01	19' 9"
250	10	6.01	19' 9"
300	12	6.01	19' 9"

## TERRABRUTE® CR RESTRAINED JOINT PIPE

### Pulling Forces

The magnitude of pulling force exerted on a pipe string during pulled-in-place type installation methods depends on a number of factors, including:

- The length of the pull
- The diameter of the pipe
- The type of soil
- Selection of drilling fluid.

TerraBrute CR has been designed to withstand extremely high pulling forces in order to perform under even the toughest conditions. While most projects will use only a fraction of the ultimate strength of TerraBrute CR, the extra strength acts as an "insurance policy" against unexpected conditions.

TerraBrute CR's ultimate pull strength has been verified by laboratory tests, and can be calculated using a semiempirical design method derived by researchers at the University of Western Ontario (UWO). The following table shows both the ultimate pulling capacity of the product (no safety factor) as well as the recommended maximum pulling capacity (2:1 safety factor).



### Bending Forces

PVC pipe is much stiffer than the pipe material most commonly used for HDD and other trenchless methods – HDPE pipe. This has led some designers to wonder if PVC is too rigid to be used for these types of applications. In fact, stiffness and flexibility are two different properties. It is possible for a material to be very stiff and strong but still quite flexible. TerraBrute CR is flexible enough for virtually any HDD or pipe bursting operation, and can be installed to a much tighter radius than other PVC products. In fact, since TerraBrute CR is more flexible than the drilling rods, there is virtually no way to "over bend" the pipe. In addition, the high stiffness of the material means that there is very little deformation of the pipe string during pulling operations. As a result, appurtenances such as services and hydrant leads can be installed immediately after pulling operations are completed.

One of the most important characteristics of the TerraBrute CR joint is that it allows significant joint deflection. A significant portion of the bending is taken up by the joints, which reduces the amount of stress exerted on the pipe bell from bending. This allows TerraBrute CR to be installed to a much tighter radius than other PVC products.

The table below shows how much TerraBrute CR can be deflected at the joint during pullback operations, as well as how much the pipe barrel itself can be bent. Most projects will involve both pipe bending and joint deflection, often at the same time.

Nominal Size		Recommended Pulling Limit		Ultimate Pulling Capacity (Straight Pull)	
mm	Inches	kN	lbs	kN	Lbs.
100	4	50	11200	100	22400
150	6	110	24700	220	49500
200	8	115	25800	230	51700
250	10	187	42100	375	84300
300	12	275	61800	550	123600

Nominal Size		Allowable Joint Deflection	Allowable Pipe Bending	Minimum Allowable Radius	
mm	in	(degrees)	(degrees)	meters	Feet
100	4	8.5	5.7	24.2	79.4
150	6	8.5	4	27.5	90.2
200	8	7.5	3	32.7	107.4
250	10	5	2.5	45.8	150.3
300	12	5	2.1	48.4	158.8

# TERRABRUTE® CR RESTRAINED JOINT PIPE

## Joint Assembly



**1** Lubricate and assemble joint as for standard PVC pressure pipe.

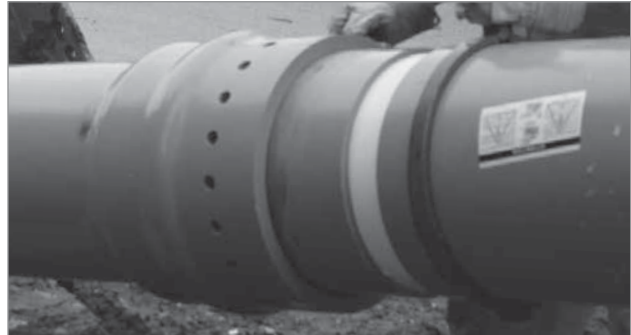

**2** Insert spigot up to the insertion line, aligning the internal ring and the pin holes.



**3** Line up the pins on the external half ring with the holes in the bell so that the half ring covers either the left or right side of the pipe

**\*\* SAFETY GLASSES MUST BE WORN DURING PIN INSTALLATION.**

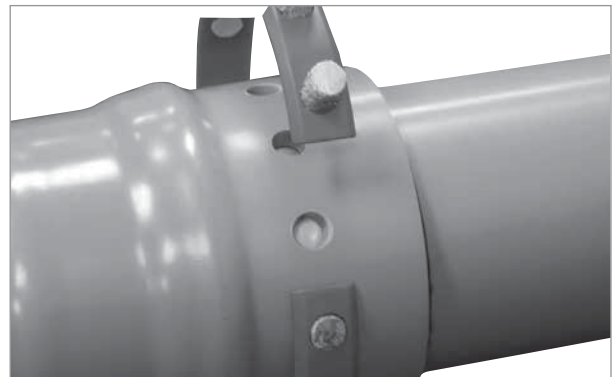

**4** One Ring at a time, place ring over pin holes and tap pins in until they bottom out on the inner groove.



## CYCLETOUGH® PIPING SYSTEMS

CycleTough piping systems are specially designed for applications where pressures are expected to cycle up and down repeatedly, such as sewage forcemains, irrigation systems and other applications. One of the most important things to remember with CycleTough systems is that the fittings are made with PVC compound that has the same hydrostatic design basis (HDB) as the pipe. Always specify a complete system of pipes and fittings from the same manufacturer to ensure matching fittings.



### Applications:

Sewage forcemains, irrigation.  
Rural water supply, water distribution and transmission.

### Standards

#### CycleTough Pipe

**CSA B137.3** – Rigid Poly (Vinyl Chloride) (PVC) Pipe for Pressure Applications

**ASTM D2241** – Poly (Vinyl Chloride) (PVC) Plastic Pipe (SDR-PR) PVC, ASTM D2241.

**NSF-61-G** listed for potable water

**BNQ 3660-950**



#### CycleTough Fittings

**CSA B137.2**

**ASTM 3139**



### Pressure Ratings

CycleTough pipe is available in long term pressure ratings from 100 to 200 psi.

For more information on how these ratings are calculated, please refer to section 3.

SDR	Long Term Rating (LTR)		Short Term Rating (STR)	
	psi	kPa	psi	kPa
41	100	690	160	1,100
32.5	125	860	200	1,380
26	160	1,100	256	1,770
21	200	1,380	320	2,210



## CYCLETOUGH® PIPING SYSTEMS

### Short Form Specifications

#### Pipes

IPSOD PVC pipe shall be manufactured from PVC compound with ASTM D1784 cell class 12454. PVC pipe will have a minimum hydrostatic design basis (HDB) of 4000 psi and a short-term strength of 6400 psi. Pipe shall be certified to CSA B137.3 and conform to ASTM B2241.

#### Fittings

Injection-molded PVC fittings shall be made from PVC compound with a minimum HDB of 4000 psi and have a pressure rating of 200 psi.

Fabricated fittings shall be made from sections of pipe certified to CSA B137.3 and fittings shall also be certified to CSA B137.3.

All pipes and fittings shall be listed to NSF Standard 61 and shall be color coded white.

### Dimensions

CycleTough pipe and fittings are manufactured with an Iron Pipe Size outside diameter (IPSOD). This outside diameter configuration is consistent with that used for Schedule piping (Sch. 40 and 80) as well as steel pipe sizes.

Size		Series 100 (SDR41)						Series 125 (SDR32.5)					
		Avg. ID		Min. Wall Thickness		Avg. OD		Avg. ID		Min. Wall Thickness		Avg. OD	
in	mm	in	mm	in	mm	in	mm	in	mm	in	mm	in	mm
4	100	4.28	108	0.11	2.78	4.50	114	4.21	107	0.14	3.50	4.50	114
6	150	6.28	160	0.16	4.12	6.63	168	6.19	157	0.20	5.18	6.63	168
8	200	8.18	208	0.21	5.32	8.62	219	8.06	205	0.27	6.72	8.62	219
10	250	10.19	259	0.26	6.66	10.75	273	10.05	255	0.33	8.40	10.75	273
12	300	12.09	307	0.31	7.90	12.75	324	11.92	303	0.39	9.96	12.75	324
14	350	13.28	337	0.34	8.66	14.00	356	13.09	333	0.43	10.9	14.00	356
16	400	15.17	385	0.39	9.90	16.00	406	14.96	380	0.49	12.5	16.00	406
18	450	17.07	434	0.44	11.1	18.00	457	16.82	427	0.56	14.1	18.00	457
20	500	18.99	482	0.49	12.4	20.00	508	18.70	475	0.61	15.6	20.00	508
24	600	22.76	578	0.59	14.9	24.00	610	22.43	570	0.74	18.8	24.00	610

Size		Series 160 (SDR26)						Series 200 (SDR21)					
		Avg. ID		Min. Wall Thickness		Avg. OD		Avg. ID		Min. Wall Thickness		Avg. OD	
in	mm	in	mm	in	mm	in	mm	in	mm	in	mm	in	mm
1-1/2	40	1.73	44.0	0.08	2.02	1.90	48.3	1.71	43.0	0.09	2.28	1.90	48.3
2	50	2.18	55.5	0.09	2.30	2.38	60.4	2.14	54.0	0.11	2.86	2.38	60.4
2-1/2	65	2.64	67.1	0.11	2.78	2.87	73.0	2.58	66.0	0.14	3.48	2.87	73.0
3	75	3.22	81.7	0.14	3.42	3.50	88.9	3.15	80.0	0.17	4.24	3.50	88.9
4	100	4.13	105	0.17	4.38	4.50	114	4.05	103	0.21	5.44	4.50	114
6	150	6.09	155	0.26	6.48	6.63	168	5.96	151	0.32	8.02	6.63	168
8	200	7.92	201	0.33	8.42	8.62	219	7.76	197	0.41	10.4	8.62	219
10	250	9.87	251	0.41	10.5	10.78	273	9.67	246	0.51	13.0	10.75	273
12	300	11.72	298	0.49	12.4	12.75	324	11.47	291	0.61	15.4	12.75	324
14	350	12.86	327	0.54	13.7	14.00	356	12.59	312	0.67	16.9	14.00	356
16	400	14.70	373	0.61	15.6	16.00	406	14.38	365	0.76	19.4	16.00	406
18	450	16.53	420	0.69	17.6	18.00	457	16.18	411	0.86	21.8	18.00	457
20	500	18.36	466	0.77	19.6	20.00	508	17.98	457	0.95	24.2	20.00	508
24	600	22.04	560	0.93	23.5	24.00	610	21.58	548	1.14	29.0	24.00	610



# CYCLETOUGH® PIPING SYSTEMS

## 90° Elbow G x G

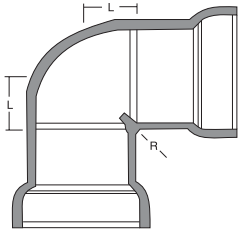

Size		L		R	
in	mm	in	mm	in	mm
2	50	1.18	29.5	0.75	18.8
2-1/2	65	1.80	45.0	1.00	25.0
3	75	2.00	50.0	1.00	25.0
4	100	2.20	55.0	1.00	25.0
6	150	2.80	70.0	1.25	31.3
8	200	4.87	121.8	1.50	37.5

## 45° Elbow G x G

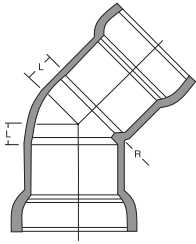

Size		L		R	
in	mm	in	mm	in	mm
2	50	0.60	15.0	0.75	18.8
2-1/2	65	1.80	45.0	1.00	25.0
3	75	1.12	28.0	1.00	25.0
4	100	1.10	27.5	1.00	25.0
6	150	1.60	40.0	1.25	31.3
8	200	2.40	60.0	1.50	37.5

## Tee G x G x G

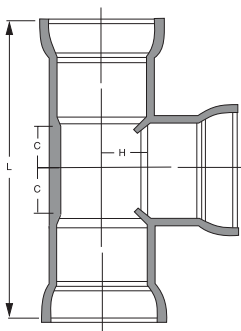

Size		C		H		L	
in	mm	in	mm	in	mm	in	mm
2	50	1.30	32.5	1.10	27.5	8.20	208.3
2-1/2	65	1.67	41.8	1.63	40.8	10.10	256.5
3	75	1.99	49.8	1.99	49.8	11.40	289.6
4	100	2.57	64.3	2.65	66.3	13.10	332.7
6	150	3.76	94.0	3.77	94.3	15.50	394.7
8	200	4.91	122.8	4.91	122.8	22.25	565.2

# CYCLETOUGH® PIPING SYSTEMS

## Tap Service Tee - NPT Outlet

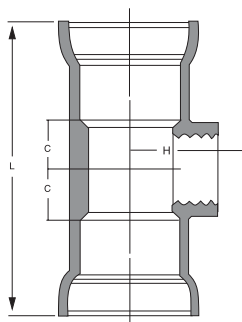

Size		C		H		L	
in	mm	in	mm	in	mm	in	mm
2 x 1/2	50 x 15	1.40	35.0	2.15	53.8	7.10	177.5
2 x 3/4	50 x 20	1.40	35.0	2.15	53.8	7.10	177.5
2 x 1	50 x 25	1.40	35.0	2.15	53.8	7.10	177.5
2 x 1-1/4	50 x 32	1.40	35.0	2.15	53.8	7.10	177.5
2 x 1-1/2	50 x 40	1.40	35.0	2.15	53.8	7.70	195.6
2-1/2 x 1/2	65 x 15	1.45	36.3	2.50	62.5	7.90	197.5
2-1/2 x 3/4	65 x 20	1.45	36.3	2.50	62.5	7.90	197.5
2-1/2 x 1	65 x 25	1.45	36.3	2.50	62.5	7.90	197.5
2-1/2 x 1-1/4	65 x 32	1.45	36.3	2.50	62.5	7.90	197.5
2-1/2 x 1-1/2	65 x 40	1.45	36.3	2.50	62.5	7.90	197.5
2-1/2 x 2	65 x 50	1.45	36.3	2.50	62.5	8.50	215.9
3 x 1/2	75 x 15	1.50	37.5	2.70	67.5	9.75	243.8
3 x 3/4	75 x 20	1.50	37.5	2.70	67.5	9.75	243.8
3 x 1	75 x 25	1.50	37.5	2.70	67.5	10.35	262.9
3 x 1-1/4	75 x 32	1.50	37.5	2.70	67.5	10.35	262.9
3 x 1-1/2	75 x 40	1.50	37.5	2.70	67.5	10.35	262.9
3 x 2	75 x 50	1.50	37.5	2.70	67.5	10.35	262.9
4 x 1/2	100 x 15	1.56	39.0	3.10	77.5	10.17	254.3
4 x 3/4	100 x 20	1.56	39.0	3.10	77.5	10.17	254.3
4 x 1	100 x 25	1.56	39.0	3.10	77.5	10.77	273.6
4 x 1-1/4	100 x 32	1.56	39.0	3.10	77.5	10.77	273.6
4 x 1-1/2	100 x 40	1.56	39.0	3.10	77.5	10.77	273.6
4 x 2	100 x 50	1.56	39.0	3.10	77.5	10.77	273.6
6 x 1/2	150 x 15	1.80	45.0	3.96	99.0	13.00	325.0
6 x 3/4	150 x 20	1.80	45.0	3.96	99.0	13.00	325.0
6 x 1	150 x 25	1.80	45.0	3.96	99.0	13.60	345.4
6 x 1-1/4	150 x 32	1.80	45.0	3.96	99.0	13.00	325.0
6 x 1-1/2	150 x 40	1.80	45.0	3.96	99.0	13.60	345.4
6 x 2	150 x 50	1.80	45.0	3.96	99.0	13.60	345.4

# CYCLETOUGH® PIPING SYSTEMS

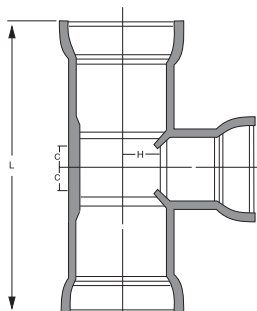

## Reducing Tee - G x G x G

Size		C		H		L	
in	mm	in	mm	in	mm	in	mm
2 x 1-1/2	50 x 40	1.30	32.5	1.10	27.5	8.20	208.3
2-1/2 x 2	65 x 50	1.67	41.8	1.63	40.8	10.10	256.5
3 x 1-1/2	75 x 40	1.85	46.3	1.60	40.0	11.40	289.6
3 x 2	75 x 50	1.85	46.3	1.60	40.0	11.40	289.6
3 x 2-1/2	75 x 65	1.90	47.5	1.60	40.0	11.40	289.6
4 x 2	100 x 50	1.90	47.5	2.00	50.0	11.90	302.3
4 x 2-1/2	100 x 65	1.90	47.5	2.00	50.0	11.90	302.3
4 x 3	100 x 75	1.90	47.5	2.00	50.0	11.90	302.3
6 x 2	150 x 50	2.40	60.0	2.80	70.0	15.50	393.7
6 x 2-1/2	150 x 65	2.40	60.0	2.80	70.0	15.50	393.7
6 x 3	150 x 75	2.40	60.0	2.80	70.0	15.50	393.7
6 x 4	150 x 100	2.40	60.0	2.80	70.0	15.50	393.7
8 x 2	200 x 50	3.85	96.3	4.87	121.8	20.10	510.5
8 x 3	200 x 75	3.85	96.3	4.87	121.8	20.10	510.5
8 x 4	200 x 100	3.85	96.3	4.88	122.0	20.10	510.5
8 x 6	200 x 150	3.85	96.3	4.88	122.0	20.10	510.5

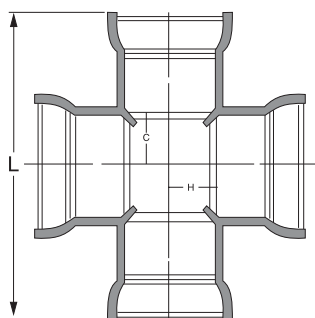

## Cross G x G x G x G

Size		C		H		L	
in	mm	in	mm	in	mm	in	mm
4	100	4.00	100.0	4.00	100.0	13.10	332.7
6	150	4.50	112.5	4.50	112.5	16.60	421.6

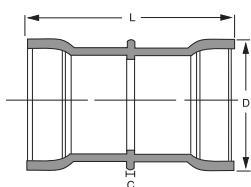

## Stop Coupling G x G

Size		L		D	
in	mm	in	mm	in	mm
2	50	8.25	209.6	3.35	83.8
2-1/2	65	9.00	228.6	4.15	103.8
3	75	9.50	241.3	5.00	125.0
4	100	11.00	279.4	6.13	153.3
6	150	12.00	304.8	8.73	218.3
8	200	12.30	307.5	10.62	265.5

# CYCLETOUGH® PIPING SYSTEMS

## Repair Coupling G x G

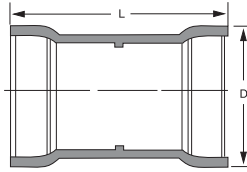

Size		L		D	
in	mm	in	mm	in	mm
2	50	8.25	209.6	3.35	83.8
2-1/2	65	9.00	228.6	4.15	103.8
3	75	9.50	241.3	5.00	125.0
4	100	11.00	279.4	6.13	153.3
6	150	12.00	304.8	8.73	218.3
8	200	12.30	307.5	10.62	265.5

## Permanent Plug Spigot

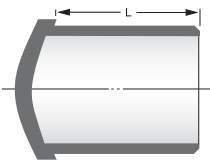

Size		L	
in	mm	in	mm
1-1/2	40	2.50	62.5
2	50	2.50	62.5
2-1/2	65	3.50	87.5
3	75	3.50	87.5
4	100	3.75	93.8
6	150	4.50	112.5

## Increaser Bushing - G x Sp

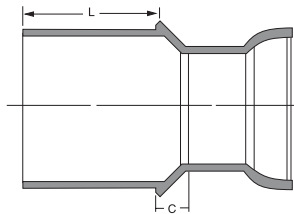

Size		L		C	
in	mm	in	mm	in	mm
1-1/2 x 2	40 x 50	2.40	60.0	0.20	5.0
2 x 2-1/2	50 x 65	2.40	60.0	0.20	5.0
2 x 3	50 x 75	3.40	85.0	0.55	13.8
2-1/2 x 3	65 x 75	3.40	85.0	0.38	9.5
2 x 4	50 x 100	3.00	75.0	0.40	10.0
2-1/2 x 4	65 x 100	3.00	75.0	0.40	10.0
3 x 4	75 x 100	3.00	75.0	0.40	10.0
2 x 6	50 x 150	4.30	107.5	0.50	12.5
2-1/2 x 6	65 x 150	4.30	107.5	0.50	12.5
3 x 6	75 x 150	4.30	107.5	0.50	12.5
4 x 6	100 x 150	4.30	107.5	0.50	12.5
4 x 8	100 x 200	5.10	127.5	0.60	15.0
6 x 8	150 x 200	5.10	127.5	0.60	15.0

# CYCLETOUGH® PIPING SYSTEMS

## Adapter - Flange x Gasket Bell

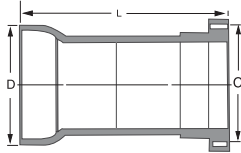

Size		C		D		L	
in	mm	in	mm	in	mm	in	mm
1-1/2	40	3.85	96.3	5.00	125.0	4.25	106.3
2	50	4.75	118.8	6.00	150.0	4.75	118.8
2-1/2	65	5.50	137.5	7.00	175.0	5.75	143.8
3	75	6.00	150.0	7.50	187.5	6.50	162.5
4	100	7.48	187.0	9.02	225.5	10.52	263.0
6	150	9.55	238.8	10.97	274.3	13.48	337.0
8	200	11.75	293.8	13.50	337.5	12.00	300.0

## Spigot Adapter G x Sp

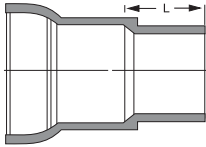

Size		L	
in	mm	in	mm
1-1/2	40	1.50	37.5
2	50	1.80	45.0
2-1/2	65	2.00	50.0
3	75	2.10	52.5
4	100	2.30	57.5
6	150	3.10	77.5

## Male Adapter G x Male Pipe Thread

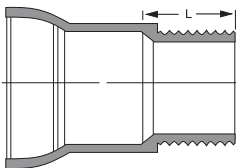

Size		L	
in	mm	in	mm
1-1/2	40	1.05	26.3
2	50	1.20	30.0
2-1/2	65	1.55	38.8
3	75	2.10	52.5
4	100	2.25	56.3
6	150	2.50	62.5

## CYCLETOUGH® PIPING SYSTEMS

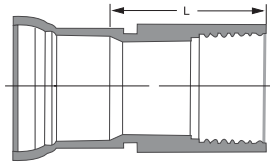

### Adapter Bell x Female IPT

Size		L	
in	mm	in	mm
1-1/2	40	2.60	65.0
2	50	3.00	75.0
2-1/2	65	3.80	95.0
3	75	4.10	102.5
4	100	4.40	110.0
6	150	5.40	135.0

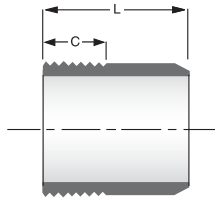

### Adapter - PE (Plain End) x Male Pipe Thread

Size		L		C	
in	mm	in	mm	in	mm
3	75	4.30	107.5	2.00	50.0
4	100	4.40	110.0	2.25	56.3
6	150	5.90	147.5	2.50	62.5

## BLUE904® PEX WATER SERVICE TUBING

Blue904 is fully certified, lightweight and flexible PEX water service tubing. Installation friendly, Blue904 will resist corrosion, maximizing water flow over the lifetime of the system.

Blue904 PEX Municipal Water service tubing has unique features and performance characteristics that make it the leading alternative to copper tubing. IPEX Blue904 conforms to CTS OD dimensions, allowing common compression fittings to be used.

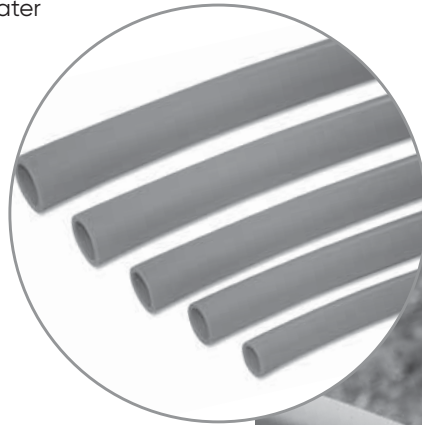

### Applications:

Water service lines that connect municipal watermains to buildings.

### Codes and Standards

Blue904 PEX water service tubing is certified to **cNSFus-PW**, **AWWA C904**, **ASTM F876**, **F877** and **CSA B137.5**.



## BLUE904® PEX WATER SERVICE TUBING

### Short Form Specification

Water service tubing shall be cross-linked polyethylene (PEX) tubing certified to NSF 14 & 16, CSA B137.5 and ASTM F876 and F877, PEX tubing shall have PPI approved pressure ratings of: 160psi @ 23°C (73°F) and 100psi @ 82°C (180°F).

The outside diameter of the pipe shall be copper tube size (CTS) and must have a standard dimension ratio (SDR) of 9.

### Pressure Rating

Sizes	Pressure Ratings	
3/4" - 2" (20mm - 50mm)	160 psi @ 73°F 100 psi @ 180°F	(1100 kPa @ 23°C) (690 kPa @ 82°C)

### Long Service Life

Blue904 will resist the effects of chlorine and scaling and will not corrode in soil. It is also less susceptible to freezing due to its low thermal conductivity when compared to copper tubing.

### Jobsite Safe

Unlike copper tubing, PEX tubing has no scrap value, eliminating the threat of jobsite theft common with copper. As a result, no special storage precautions are necessary.

### Packaging and Markings

Blue904 is available in 100 ft and 300 ft coils and is packaged in boxes for UV protection and portability. Each coil has footage markings to assist during installation and is identified with product name, size, certifications and manufacturing date.

### Dimensions

PEX Tubing may be shaped by hand to a minimum radius of 8 times the outside diameter of the tubing. External end supports or sleeves may be required to maintain desired position and shape.

Nominal Size		I.D.		Minimum Bend Radius	
mm	Inches	mm	inches	mm	inches
19	3/4	17.3	0.68	178	7
25	1	22.2	0.88	229	9
38	1-1/2	31.5	1.24	330	13
51	2	41.3	1.63	432	17

Note: When using pipe in coils and bending against the coil direction, the minimum bending radius is 3 times the radius given above. (e.g. 3/4" CTS pipe = 3 x 4.5" = 13.5")

Note: To avoid kinking, care should be taken when bending the tubing in sub-zero temperatures. For bending in cold temperatures, use a minimum bend radius of 2 times that listed in the chart.



## GOLD901™ WATER SERVICE TUBING

Gold901™ is a lightweight, easy to install, 200 psi rated water service tubing that can be used on both the municipal and private-side of a project.

Gold901 is conveniently available in both coils and reels and is available in 3/4" to 2".



### Applications:

Water service tubing

### Codes and Standards

Gold901 is manufactured to Copper Tube Size (CTS) from High-Density Polyethylene (HDPE) and is third-party certified and listed to AWWA C901, CSA B137.1, and NSF 61.

Canadian Standards Association

American Water Works Association

NSF Standards 14 & 61, Uniform Plumbing Code

American Society for Testing and Materials

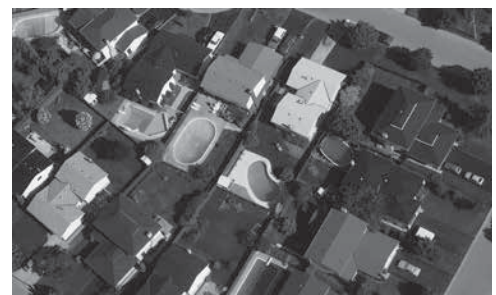

## GOLD901™ WATER SERVICE TUBING

### Dimensions

Nominal Size		Coil Length feet	Product Code	O.D. Avg (in)	I.D. Avg. (in)	Min. Bend Radius (in)
in	mm					
3/4	20	100	121402	0.875	0.671	19
		200	121403			
		400	121404			
		500	121405			
		3000	121406			
1	25	100	121407	1.125	0.863	23
		150	121408			
		200	121409			
		300	121410			
		500	121411			
		1000	121412			
		1500	121413			
1-1/4	32	100	121414	1.375	1.055	30
		300	121415			
1-1/2	40	100	121416	1.625	1.245	34
		250	121417			
		400	121418			
		1000	121419			
2	50	100	121420	2.125	1.629	44
		200	121421			
		500	121422			

**Note:** Custom coil and reel sizes may be available upon request.

#### Advantages

##### Non-Corroding

Resistant to corrosive soils, aggressive water, stray electrical currents and moist environments

##### Lightweight

A 200 foot coil of 3/4" Gold901 weighs 20 lbs

##### Sequential Markings

Every 2 or 5 feet

##### Superior Flow

Hazen Williams C-Factor = 150

##### High Pressure

Rated at 200 psi at 73°F (1380 kPa at 23°C)

## Q-LINE® WATER SERVICE TUBING

Q-Line is a composite pipe made with a layer of aluminum sealed between two layers of a special thermoplastic designed for use as water service tubing. The result is a pipe with all the advantages of both materials, and none of the weaknesses. It has the strength of metal service tubing and will never corrode as the metal is sealed in plastic. It rolls out flat like a metal pipe, but it is lightweight like a plastic pipe.

### Non-Conductor

Roughly 370 serious electric shock incidents occur in the U.S. water utility industry every year<sup>1</sup>. While the AWWA has opposed the practice of grounding to the water system for over 80 years, it is still routinely done, despite the availability of grounding rods and plates. Since Q-Line is a non-conductor, it eliminates the risk of electric shock from stray currents. Specifying Q-Line helps to eliminate the risk to municipal workers.

### Effective Permeation Barrier

Chemical permeation is a real issue with small diameter service tubing made of PE. Q-Line's aluminum core is an effective barrier and has been tested against the most aggressive contaminants such as termiticides.

### Zero Scrap Value

The high scrap value of copper pipe has resulted in significant pilferage problems on job sites across North America. This has resulted in storage problems as all copper pipe must be properly secured each day.

### Applications:

Water service lines, reclaimed water lines (purple pipe available)

### Codes and Standards

Q-Line water service tubing is certified to **cNSFus-PW**, **ASTM F1282** and certified to **CSA B1379**, and meets **AWWA C903** requirements.

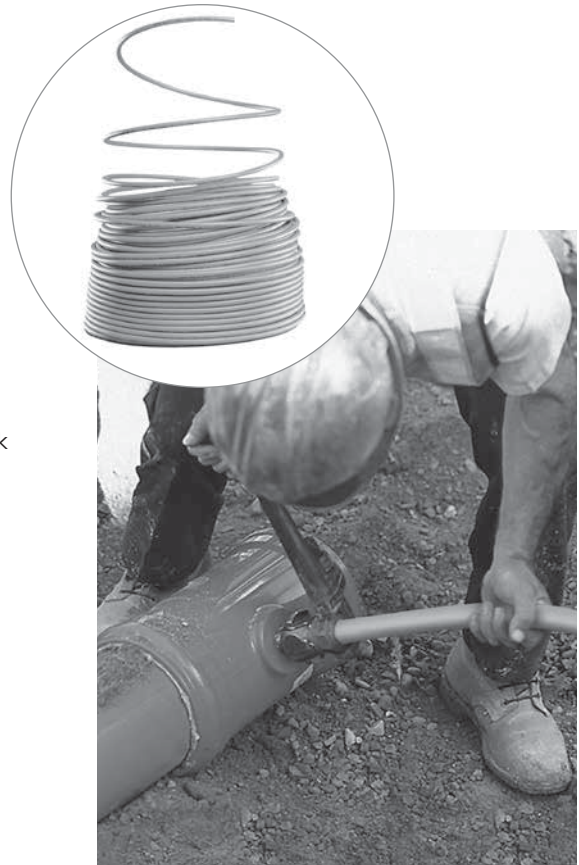

## Q-LINE® WATER SERVICE TUBING

### Short Form Specifications

Water service tubing shall be composite PERT-AL-PERT tubing manufactured in accordance with the requirements of AWWA C903 and certified to CSA B137.9 and ASTM F1282. It shall have a long term pressure rating of 1380kPa at 23°C (200 psi at 73°F) and 690kPa at 82°C (100 psi at 180°F). The pipe shall be third-party tested and certified to comply with NSF-PW potable water and NSF CL-TD chlorine resistance requirements. The service tubing shall be color coded light blue as manufactured by IPEX under the trade name "Q-Line" or approved equal.

Fittings for composite PERT-AL-PERT tubing shall be brass water service fittings conforming to AWWA C800.

### Pressure Ratings

Q-Line is rated at 200 psi working pressure at 23°C (73°F). In addition, Q-Line is rated at 100 psi at 82°C (180°F). Since most water services operate at between 40 and 70 psi, even a back-up of hot water from the building into the water service will not compromise Q-Line.

### Flow Rates

Q-Line has larger inside diameters than CTS PE piping and a better flow coefficient than copper pipe (C = 150 for Q-Line versus only 100 for copper pipe.) This gives Q-Line the best flow rates in the industry. And unlike copper pipe, Q-Line does not corrode or allow build-up of flow-constricting deposits on the ID of the pipe.

**Table 2 – Q-Line Flow Rates**

Flow Rate (U.S. gpm)	Head Loss (psi/100 ft)		Velocity (fps)		Flow Rate (l/s)	Head Loss (kPa/100m)		Velocity (m/s)	
	3/4"	1"	3/4"	1"		20mm	25mm	20mm	25mm
1.0	.1	0.0	.7	0.4	0.1	7.2	2.4	0.3	0.2
2.0	.5	0.2	1.3	0.8	0.2	26.1	8.8	0.6	0.4
3.0	1.0	0.4	2.0	1.3	0.3	55.3	18.7	1.0	0.6
4.0	1.8	0.6	2.6	1.7	0.4	94.2	31.8	1.3	0.8
5.0	2.7	0.9	3.3	2.1	0.5	142.4	48.1	1.6	1.0
6.0	3.8	1.3	4.0	2.5	0.6	199.6	97.4	1.9	1.2
7.0	5.0	1.7	4.6	3.0	0.7	265.5	89.7	2.2	1.4
8.0	6.4	2.2	5.3	3.4	0.8	340.0	114.8	2.6	1.6
9.0	8.0	2.7	5.9	3.8	0.9	422.9	142.8	2.9	1.8
10.0	9.7	3.3	6.6	4.2	1.0	514.0	173.6	3.2	2.0
11.0	11.6	3.9	7.2	4.6	1.1	613.3	207.1	3.5	2.2
12.0	13.6	4.6	7.9	5.0	1.2	720.5	243.3	3.8	2.5
13.0	15.7	5.3	8.5	5.5	1.3	835.7	282.2	4.1	2.7
14.0	18.0	6.1	9.2	5.9	1.4	958.6	323.7	4.5	2.9
15.0	20.5	6.9	9.9	6.3	1.5	1089.2	367.8	4.8	3.1
16.0	23.1	7.8	10.5	6.7	1.6	1227.5	414.5	5.1	3.3
17.0	25.8	8.7	11.2	7.1	1.7	1373.4	463.8	5.4	3.5
18.0	28.7	9.7	11.8	7.6	1.8	1526.8	515.5	5.7	3.7
19.0	31.7	10.7	12.5	8.0	1.9	1687.5	569.8	6.1	3.9
20.0	34.9	11.8	13.2	8.4	2.0	855.7	616.6	6.4	4.1
21.0	38.2	12.9	13.8	8.9					
22.0	41.7	14.1	14.5	9.2					
23.0	45.2	15.3	15.1	9.7					
24.0	-	16.5	-	10.1					
25.0	-	17.8	-	10.5					
26.0	-	19.2	-	11.0					
27.0	-	20.6	-	11.4					
28.0	-	22.0	-	11.8					
29.0	-	23.5	-	12.2					
30.0	-	25.0	-	12.7					

## Q-LINE® WATER SERVICE TUBING

### Dimensions

Q-Line has unique inside and outside diameters that are different both from copper and conventional PE service tubing. Easily installed adapters that allow Q-line to be used with standard brass fittings are widely available. Unlike PE pipe, Q-line does not require a stiffening insert to be used.

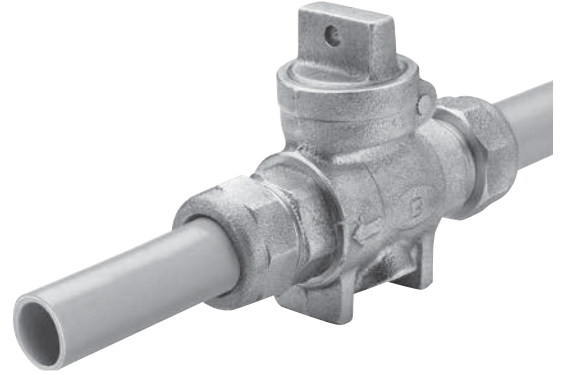

Nominal Size		Avg. ID		Min. Wall Thickness		Avg. OD		Weight		Volume		Min. Bending Radius	
in	mm	in	mm	in	mm	in	mm	lbs/100ft	kg/100m	U.S. gal/ft	l/m	in	mm
3/4	20	.79	20	.10	2.5	.98	25	12.4	18.4	.025	.314	5.0	125
1	25	.98	25	.14	3.2	1.26	32	21.0	31.2	.040	.500	6.3	160

## STANDARDS FOR PVC AND PVCO PRESSURE SYSTEMS

### Standards and Certifications

There are two main classes of standards governing PVC piping systems, those which define products that are certified by a third party and those which define products that are non-policed. While non-policed standards can be very useful in a specification, the standards that are certified by a third party offer the customer an additional level of quality assurance. Third-party certification means that an independent organization has scrutinized the manufacturing process and QA/QC procedures for the products in question, and has verified that they meet the minimum requirements for approval. Compliance with a non-policed standard requires the customer to take the manufacturer at his word that his product conforms to the standard. Most manufacturers perform accurate in-house testing and are honest and up front, and if they state that their products meet a certain standard, you can be quite certain that they do. There is no question however, that certification by a third party provides a much higher degree of assurance that the products in question in fact meet the applicable standard and that they will perform as stated.

### Third-Party Certified Standards

#### Canadian Standards Association (CSA)

CSA B137.0	CSA B137.1	CSA B137.2
CSA B137.3	CSA B137.3.1	CSA B137.5
CSA B137.9		

CSA staff visit all IPEX plants producing certified product several times each year. In addition to witnessing manufacturing and QA/QC procedures, CSA staff also inspect records, and select product samples for independent testing. The CSA standards refer to a wide variety of external standards (such as ASTM standards) for items such as testing methods. As a result, certifying the product to a CSA standard often has the effect of indirectly certifying the product to other standards as well.

#### Factory Mutual (FM)

FM 1612

This third-party-certified standard is often required whenever the piping system is going to be used as a fire-protection line. In the case of FM, insurance regulations sometimes dictate the standard to be used. The certification methods are similar to those used by the CSA.

#### National Sanitation Foundation (NSF)

NSF 14                      NSF 61

Both of these standards are third-party-certified. The NSF 14 standard includes two major areas: material testing for potability and product testing for performance. Listing to

this standard means that the pipe/fitting material will have no adverse effect on water quality and that the pipe/fitting product will meet the performance requirements of the standard. NSF 61 includes the potability testing portion of NSF 14.

#### Underwriters Laboratories (UL, ULI, ULC)

UL 1285

This standard is also third-party-certified and is often required when the pipeline is used in fire-protection applications. Certification methods are similar to those employed by CSA.

### Accreditation of Standards Labs and Organizations

While the standards discussed above are normally certified by a third party, that third party can sometimes be a separate organization. For example, Intertek Warnock-Hersey is a laboratory accredited by the Standards Council of Canada, and as a result, it is capable of certifying products to standards. It is common for Intertek Warnock-Hersey to certify a product to a CSA standard, and NSF also has this capability.

### Non-Certified Standards

American Water Works Association  
 AWWA C900    AWWA C901    AWWA C903  
 AWWA C904    AWWA C907  
 AWWA C909 certified by NSF for Bionax

C900 and C907 deal with PVC pressure pipe and fittings. C909 covers PVCO pressure pipe (Bionax) and C903 is for composite service piping (Q-line). C901 is for water service tubing (Gold901) and C904 is for PEX water service tubing (Blue904). AWWA standards are used when specifying water transmission or service piping.

### ASTM Standards (Various standards)

ASTM Standards are referenced by all the above standards. They cover everything from materials to manufacturing to testing to installation, which is why there are so many different ASTM standards associated with our products.

### Design and Installation Standards

AWWA C605

This standard provides guidance and instruction for underground installation of PVC/PVCO piping systems.

AWWA Manual M23

The M23 Manual includes information for proper design and installation of PVC and PVCO pipe.

## NOTES

## SECTION 2: PROPERTIES OF PVC PRESSURE PIPE AND PRESSURE SYSTEM DESIGN

### INTRODUCTION

Properly designed and installed PVC piping systems will last virtually forever. Recent research has unearthed PVC systems that were installed in the 1930's that exhibit virtually no reduction in serviceability. This section focuses on the physical properties of PVC pipes and fittings, as well as how to approach some of the conditions likely to be encountered during a project.

Various design issues will also be addressed including;

- The hydrostatic design basis (HDB) of PVC pipe
- Calculating pressure ratings
- Hydraulics and headloss calculations
- Restraint design
- Installation in contaminated soils
- Surge pressures in PVC pipe
- Air entrapment and proper location of air release valves
- Thermal effects
- Design for cyclic fatigue

### MATERIAL PROPERTIES OF PVC

#### Design Life

Designers should use a minimum 100 year design life when carrying out lifecycle costing calculations for PVC systems. This is backed up both by research and real world installations.

#### Current Research

PVC pressure pipes have been in service for over 70 years in Europe<sup>2</sup>. Samples of 70 year old pipe have been excavated and have exhibited no reduction in serviceability. PVC pipe's installed history in North America is approaching 50 years, with a similar record for excellent service. The single most destructive force attacking our municipal water and sewer infrastructure is corrosion. By using materials that are immune to electrolytic corrosion or chemical attack, designers eliminate the single most common problem associated with buried infrastructure.

Research dealing with the longevity of PVC pipe in various conditions is on-going, however there have been a number of notable research papers presented over the years, including:

- AWWA Research Foundation – "Quantifying Future Rehabilitation and Replacement Needs of Watermains", 1998

This study used a highly specialized computer model to estimate the life of various materials based on past performance. In the one North American city studied with a significant amount of PVC pipe installed, PVC was rated at a minimum 100 years while concrete and ductile iron were rated at 85 and 60 years respectively.

- "PVC Pipe Study – Performance of PVC Water Main Pipe installed in the City of Edmonton between 1977 and 1994"

A comprehensive study of PVC pipe used in the City's water distribution system rated its service life at a minimum of 88 years with minimal maintenance.

Case Studies from Europe and North America including:

- Dallas, Texas – A PVC sewer pipe installed in 1973 was excavated and subjected to each of the tests outlined in ASTM D3034. The results show that the excavated pipe still met all the standards applicable to new pipe
- Denmark – A PVC Sewer pipe installed in 1963 was excavated and testing results show that the pipe has the same material properties as newly produced pipe. Most of the pipes installed were directly into native soil without bedding, and have performed acceptably for over 40 years.

These research papers are available upon request from your IPEX marketing representative at [marketing@ipexinc.com](mailto:marketing@ipexinc.com) or visit the IPEX website at [ipexna.com](http://ipexna.com).

<sup>2</sup> Hulsman, Nowack, "70 Years of Experience with PVC Pipes" Conference Paper, Plastic Pipes XII, Milan, April 2004



## Design Strength for PVC Pipe

While Blue Brute pipes are casually referred to as PVC pipes, in reality they are made of a special PVC compound designed specifically for use in piping systems. The Hydrostatic Design Basis (HDB) of a PVC compound is the minimum stress that the material is able to withstand over a given time. The HDBs of IPEX compounds are established through both short-term and long-term testing (up to 10,000 hours sustained pressure). By plotting the results on a logarithmic scale, the 50 or 100 year design stresses can be easily extrapolated. The diagram below shows a typical life line for a PVC compound.

**Figure 1 – Stress Regression Line - Cell Class 12454**

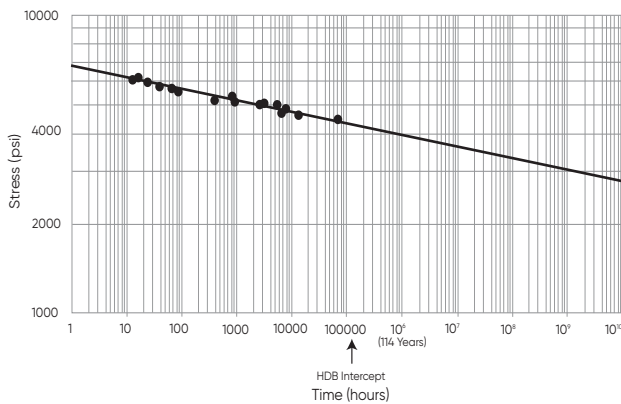

As can be seen from the diagram, PVC compounds have:

- **High Short Term Strength**

While all IPEX PVC pressure pipes have a long-term hydrostatic design basis of 4000 psi, in the short term their strength is much higher – 6400 psi. This means that the pipe can easily withstand extremely high short term pressures, such as those generated by transient surges. For example, although a DR18 pipe is rated at 235 psi, it routinely withstands well over 750 psi during quick burst tests.

- **Dependable Long-Term Strength**

At normal operational stress levels, the lifespan of the material is virtually unlimited. Because of the large reserves of strength, even stresses that build to levels above the normal safety factors can be accommodated.

## Summary of Material Properties

All PVC pressure pipes are made of a proprietary PVC compound formulated specifically for pressure pipe applications.

**Table 3 – Summary of Properties for PVC Pipe**

Material Property	
Hydrostatic Design Basis (HDB)	27.6 MPa (4000 psi)
Short-Term Strength (STS)	44.1 Mpa (6400 psi)
Cell Class (ASTM F1784)	12454
Young's Modulus	2,760 Mpa (400,000 psi)
Poisson's Ratio	0.38

## Chemical Permeation and Installation of PVC Pipe in Contaminated Soils

There is a misconception among some designers that PVC pipe is unsuitable for installation in areas that contain soils contaminated by organic compounds. This misconception stems from the fact that there have been rare occurrences where small diameter plastic service lines have been permeated by organic chemicals. This is not an issue with larger diameter PVC pipes because:

1. The vast majority of documented permeation incidents occurred with thin wall service pipes made of lower density materials such as polybutylene or polyethylene<sup>3</sup>. These small diameter pipes are indeed unsuitable for contaminated soils. Only service pipe with a built in permeation barrier (such as Q-Line) should be used in these cases.
2. PVC pipe has an effective permeation time of many centuries, even at extremely high levels of environmental contamination. This has been conclusively proven through research<sup>4</sup>.
3. The high density and non-porous finish of PVC pipe makes it very difficult for permeation to occur. Samples of IPEX pressure pipe were partially filled with gasoline and sealed for seven years. When the inside surface of the pipe was examined microscopically, no evidence of permeation was found<sup>5</sup>.

The most important consideration in contaminated soils is the gasket material. To ensure safe, long-term operation of the pipeline, oil-resistant (nitrile) gaskets should always be specified in these areas.

<sup>3</sup> Jenkins, Thompson, "Review of Water Industry Plastic Pipe Practices", AWWA Research Foundation, 1987

<sup>4</sup> Berens, A.R., "Prediction of Chemical Permeation through PVC Pipe", Journal of the AWWA, November 1985

<sup>5</sup> Hoogensen Metallurgical Engineering Ltd., "Examination of Submitted PVC Pipe Section", Report to IPEX, December 1998

## UV Resistance

PVC pipe can become discolored when exposed to direct sunlight for a long period of time. This discoloration affects only the surface of the material (to a depth of 0.003 inches), and does not appreciably affect the performance of the pipe. A slight reduction in the impact strength of the pipe occurs, while the tensile strength and the modulus of elasticity are unaffected. If gasketed PVC pressure piping will be used in an exposed location, painting the surface of the pipe with a latex-based paint, or covering it with an opaque barrier will eliminate the effects of U.V. exposure.

The vast majority of gasketed pressure piping is installed underground, eliminating the issue of UV exposure.

## Thermal Effects – Pressure Derating

PVC is a thermoplastic, which means its mechanical properties change with temperature. The pressure rating for PVC pipe (and most other thermoplastic piping materials) is calculated at 73°F (23°C). Above that temperature, the tensile strength of the material decreases, and the pressure rating must be de-rated by the factors shown in the table below. The maximum recommended service temperature for Blue Brute and Centurion PVC pressure pipe is 140°F (60°C). Bionax pipe uses the same table with the exception that the maximum recommended temperature is 130°F (54°C).

**Table 4 – Temperature Effects on PVC Pressure Pipe**

°C	°F	Multiply the pressure rating by these factors
32	90	0.75
38	100	0.62
43	110	0.50
49	120	0.40
54	130	0.30
60	140	0.22

## Thermal Effects – Expansion and Contraction

While buried applications seldom involve significant temperature variations, applications such as bridge crossings or casing installations can have temperature variations. When considering the use of unrestrained joints or TerraBrute CR joints, expansion and contraction should be calculated per length of pipe. If the joints are restrained using conventional restrainers, or a solvent cemented joint is used, expansion and contraction should be calculated using the full length of restrained pipe.

Material	Expansion Coefficient in/in/°F	Expansion Coefficient in/100ft/10°F	Expansion Coefficient mm/mm/°C	Expansion Coefficient mm/10m/10°C
PVC	$3.0 \times 10^{-5}$	0.36	$5.4 \times 10^{-5}$	5.4
PVCO	$3.1 \times 10^{-5}$	0.36	$5.4 \times 10^{-5}$	5.4
HDPE	$12.0 \times 10^{-5}$	1.44	$14 \times 10^{-5}$	21.6
Ductile Iron	$0.62 \times 10^{-5}$	0.07	$1.1 \times 10^{-5}$	1.1
Concrete	$0.55 \times 10^{-5}$	0.07	$1.0 \times 10^{-5}$	1.0
Steel	$0.65 \times 10^{-5}$	0.08	$1.2 \times 10^{-5}$	1.2

## DESIGN CALCULATIONS

How to Calculate Pressure Capacity

The ISO Equation for thermoplastics makes calculating required dimension ratios and pressure capacities very simple.

While it is referred to as the ISO Equation, it was actually developed in 1852 for use with all sorts of pressure vessels, and has been used ever since. The derivation is simple.

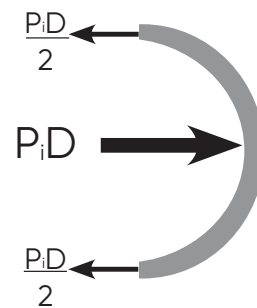

Referring to the figure, we can see that the force in the pipe wall is:

$$\text{Force} = \left( \frac{P_i D}{2} \right)$$

Therefore, the maximum stress in the pipe wall is:

$$\sigma_{\max} = \frac{P_i \bar{D}}{2t}, \text{ where } \bar{D} = \text{the average diameter of the pipe}$$

$$\bar{D} = D_o - t \therefore \sigma_{\max} = \frac{P_i(D_o - t)}{2t}$$

$$\text{But since } DR = \frac{D_o}{t}, \text{ then } \sigma_{\max} = \frac{P_i(DR - 1)}{2}$$

The conservative design procedure of PVC and PVCO pipe requires that a safety factor be applied to the Hydrostatic Design Basis (HDB) in order to arrive at a hydrostatic design Stress (S). This design stress then becomes the maximum allowable stress in the material. It is important to note that the short and long term *strengths* of each material are different and, therefore, the short-term and long-term *design stresses* will be different.

The safety factors for all PVC/PVCO pressure pipes in North America have traditionally been either 2.0 or 2.5, depending on the application and the standard governing the design. The new standards now use a safety factor of 2.0 for all cases.

$$S = \frac{\sigma_{\max}}{SF}$$

$$S = \frac{P(DR - 1)}{2} \therefore P = \frac{2S}{(DR - 1)}$$

This form of the equation allows the pressure capabilities of a given dimension ratio to be quickly and easily calculated.

### Calculating a Pressure Rating (CSA) or Class (AWWA)

There are two ratings for every PVC pipe – a long term pressure rating (LTR) which is used for evaluating working pressure capacity, and a short term pressure rating (STR) designed for evaluating surge and pressure capability.

To calculate an STR, simply apply the ISO equation using the short term strength:

$$S = \frac{\sigma_{max}}{SF}$$

Recall that:

$$S_{str} = \frac{6400}{2.0} = 3200 \text{ psi}$$

For short term stresses, AWWA standards set the safety factor (SF) = 2.0. Using the short term strength gives:

Therefore for DR41 pipe, the STR is given by

$$STR = \frac{2(3200)}{(41 - 1)} = 160 \text{ psi}$$

$$S_{tr} = \frac{4000}{2} = 2000 \text{ psi}$$

For long term stresses, the safety factor is also set at 2.0: Using the HDB gives:

$$LTR = \frac{2(2000)}{(41 - 1)} = 100 \text{ psi}$$

Applying the ISO Equation:

The table below shows both the LTR and the STR for various thicknesses of PVC pipe:

SDR	Long Term Rating LTR* (2:1 S.F.) (psi)	Short Term Rating STR (2:1 S.F.) (psi)
51	80	128
41	100	160
32.5	125	200
26	160	256
25	165	264
18	235	376
14	305	488

### Calculating Friction Headloss in PVC Piping Systems

One of the advantages in using PVC pipe is that its smooth inside finish dramatically reduces friction headloss when compared to other materials. As a result, pumping costs are lower and flows are higher when considering the same nominal diameter between materials.

The Hazen-Williams equation is one of the most commonly used methods for calculating friction headloss in a pipeline. It allows the friction headloss to be easily calculated for any piping system using flow coefficients that reflect the roughness of the piping material. Research has established that the Hazen-Williams flow coefficient for PVC pipe can vary between 155 to 165 for both new and previously used PVC pipe<sup>6</sup>. Therefore, a conservative coefficient of 150 is appropriate for all design situations. This value is also recommended by the AWWA M23 Design Manual.

$$V = 1.318Cr^{0.63}S^{0.54} \quad \text{in USCS Units}$$

$$V = 0.8492Cr^{0.63}S^{0.54} \quad \text{in SI Units}$$

Where:

V = average pipe velocity, ft/s (m/s)

C = Hazen-Williams Friction factor (150 for PVC Pipe)

R = Hydraulic radius (D/4 for a full pipe), ft (m)

S = Hydraulic gradient or frictional head loss per unit length of pipe, ft/ft, (m/m)

<sup>6</sup> Uni-Bell PVC Pipe Association, "Handbook of PVC Pipe – Design and Construction", fourth edition, (August 2001)

### Comparing Headloss Among Various Piping Materials

For any given nominal diameter of pipe, there are two factors which will largely dictate the headloss per unit length:

1. Internal diameter – It is the internal diameter of the pipe that should be used for hydraulic calculations, not the nominal diameter. A larger internal diameter promotes a greater fluid flow and therefore a lower headloss.
2. Internal friction coefficient – While internal diameter is important, the influence of the pipeline’s internal finish should not be neglected. While PVC and other plastics can sustain a smooth inside surface indefinitely, other materials tend to become rougher as a result of corrosion by-products forming over the long term. As a result, older iron pipes have been shown to have friction factors less than 100.

While experimental data has shown that the “C” factor can be as high as 155–165 for both new and used PVC pipe, AWWA M23 Manual recommends a “C” factor of 150 for PVC<sup>7</sup>.

**Table 5 – Hazen-Williams “C”-Factors**

Material	“C” Factor
Plastic (PVC, PVCO & HDPE)	150
Iron (new)	130
Iron (20 yrs old)	100

Comparing various materials it can be seen that PVC pipe has a much lower headloss at any given flow than other non-plastic piping materials:

- Class 52 iron pipe has a slightly larger inside diameter than DR18 PVC, but its low long-term C factor of 100 or less results in poor flow characteristics.
- SDR9 HDPE has a high C factor of 150, however it has a much thicker pipe wall and thus has a much smaller inside diameter than PVC DR18.

**Figure 2 – Pipe Material**

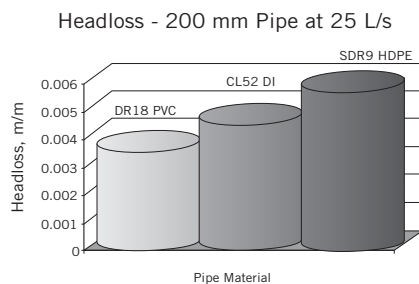

### Calculating Surge Pressures – PVC Pipe

Surge pressures (water hammer) are generated in a piping system whenever the fluid flowing in that system changes velocity. These changes in velocity can be caused by many things, including:

- The operation of valves and pumps
- Entrapped air being expelled
- Changes in demand

There are two main types of surge pressures – transient surges that occur as the system moves from one steady state condition to another (ie: the closing of a single valve), and cyclic surges, that occur as part of the normal operation of some types of pipelines. A good example of this is a sewage forcemain, where a pump is activated each time the level in a wet well reaches a certain point.

The magnitude of pressure surges is dependent upon a number of things, including the type of fluid being pumped, the magnitude of the velocity change, and also the type of pipe material. Rigid piping materials typically generate much higher surge pressures than flexible systems, which are able to absorb much more of the shock generated by a surge. In addition, the high short term strength of PVC allows it to have a much higher safety factor against short term pressures than other piping materials.

The calculation of transient effects in a large piping system (regardless of the piping material) is a complicated procedure requiring considerable expertise. Fortunately, there are many engineering firms that are highly qualified to undertake this type of analysis. IPEX has worked closely with some of these experts, and we would be happy to refer interested designers to them. We highly recommend that detailed transient analysis be performed on all systems, particularly large diameter systems.

While a detailed analysis can be beneficial, it is possible to calculate the magnitude of individual surges in a pipeline using the elastic wave theory of surge analysis. The magnitude of the surge pressure caused by a rapidly closing valve, for example, is related to the rate of change of the flow, while the rate of travel of the pressure wave is related to the speed of sound in the fluid (modified by the piping material).

<sup>7</sup> AWWA Manual M23, 2<sup>nd</sup> Edition – PVC Pipe – Design and Installation, 2002, American Water Works Association  
<sup>8</sup> “Pump Handbook – Third Edition” – Karassik, Messina, Cooper & Heald, pp.8.36

### Calculating Wave Velocity – Pipe

$$a = \frac{4,660}{\sqrt{(1 + (k/E) (DR - 2))}}$$

Where:

- a = Wave velocity, ft/s
- K = Bulk fluid modulus (300,000 psi for water)
- E = Modulus of Elasticity for the pipe (400,000 psi for PVC and 500,000 psi for PVCO)

### Surge Pressure – PVC Pipe

Once the wave speed has been calculated, the maximum pressure surge can be calculated using the equation:

$$P = \frac{a(\Delta V)}{(2.31) g}$$

Where:

- a = wavespeed (ft/s)
- $\Delta V$  = maximum velocity change (ft/s)
- g = acceleration due to gravity (32.2 ft/s<sup>2</sup>)
- P = maximum pressure surge (psi)

Applying the equations to all DRs of PVC pipe, assuming a 1 ft/s (0.3 m/s) stoppage, gives the results in the table below:

SDR	PVC Surge Pressure (psi)
51	10.8
41	11.4
32.5	12.8
26	14.5
25	14.7
18	17.4
14	19.8

### Vacuum Pressures

While pipe joints are tested to –10.8 psi to meet CSA Standards, IPEX has simulated negative pressures far in excess of full vacuum (–14.7 psi) by applying external pressures in excess of 100 psi. This proves conclusively that IPEX pipe joints can easily withstand full vacuum pressures.

### Calculating Surge Pressures – PVCO Pipe

For PVCO pipe, DR is not used. Instead,  $D_o/t$  is the dimension based variable for calculating wave velocity. The modulus of elasticity for calculating surge pressures is 500,000 psi. Using the equations above and the PVCO values, the surge pressure for a velocity change of 0.3 m/s (1.0 fps) in PC 235 PVCO pipe is 14.6 psi.

### Air Entrapment in Pipelines

Air in pipelines can cause significant difficulties in any pipeline system, and should be avoided wherever possible. This can be accomplished by careful design of the pump or gravity inlet, employing proper filling and testing procedures, laying the pipe to grade wherever possible and by properly siting and sizing air release valves.

Some of the problems caused by air entrapment include:

1. Air pockets can reduce the amount of cross sectional area available for fluid flow at some points in the pipeline. This can result in higher headloss and fluctuations in flow rates caused by air movement
2. Flow fluctuations can cause surge pressures in the pipeline
3. Release or venting of the air can cause extremely high surge pressures.

### Sources of Air in Pipelines

The most common air sources are:

- Entrapment of air during filling operations
- Entrapment at the pump or gravity inlet
- Release of dissolved air from the fluid in the pipeline
- Air intake from air release valves

### Problems Associated with Air Entrapment

The key problem with air entrapment is that at some point the air may be vented in an uncontrolled way. As an air pocket travels along a pipeline, it may reach an area where it can be vented. This could be at an air release valve (good) or perhaps at a gasketed joint (bad). The gasketing systems in most pipelines are designed to work with water, not air. While in most cases the gasket will hold back a high pressure air pocket, at some point the gasket may be blown out of the joint, causing a rapid release of air. Since the air can be vented extremely quickly, the air pocket collapses at an extremely high rate. The water surges toward the orifice created by the blown gasket, but cannot be expelled at the same velocity as the air due to its much higher density. The result is a rapid deceleration of the flow and a huge transient shock wave – sometimes at a magnitude that can cause pipe failure.

## Air Release Valves

Air release valves are designed to exhaust air under various different pressure conditions in the pipeline, while restricting the flow of liquid. Air release valves are different from Air/Vacuum release valves in that Air/Vacuum release valves have a much larger orifice and are designed to exhaust or intake very large volumes of air, such as during the filling or draining process. The orifice size for an air release valve is generally between 1/16" and 1/4" diameter, while air/vacuum release valves can be between 1" and 8".

A third type of valve combines the two functions, and is called a combination air/vacuum release valve. It contains both a large and a small orifice, the larger being open during filling and draining operations, and the smaller being open continuously to exhaust any air that might collect during normal operation of a pipeline.

Automatic air release valves with a riser diameter to main pipe ratio,  $d/D$ , in the order of 0.01 should be used when untrained personnel fill or test the pipeline. Air release valves in this size range tend to limit the passage of air and allow time for the water to slow down before reaching the vent.

Hydrants are not useful for the venting of air from pipelines. The reason is that hydrant leads typically are located at the 3 o'clock or 9 o'clock position on a pipeline. Air vents must be located at high points (ie at 12 o'clock) to be effective.

## Pipeline Testing and Air Entrapment

The initial filling and testing of a pipeline is one of the most critical events in the lifetime of a pipeline system. The reason is that the potential for air entrapment is highest during this period. As a result, Design Engineers should include details and procedures covering filling and testing in their project specifications:

1. Pipelines should be installed at a grade which results in a minimum of high points. Abrupt transitions and sharp peaks should be avoided.
2. Automatic air and vacuum release valves should be properly sized and installed at all high points or other areas where air could be expected to accumulate
3. The average water velocity when filling the pipeline should not exceed 1 ft/s (0.3 m/s)
4. All air should be purged from the pipeline before checking for leaks or performing pressure or acceptance tests on the system
5. If a large quantity of water is needed to increase the pressure during testing, then entrapped air or a leak is possible. Testing should be discontinued until the source of the problem is identified

Nominal Size		Max Filling Rate	
In	mm	gpm	L/s
4	100	40	2.5
6	150	87	5.5
8	200	157	9.9
10	250	245	15
12	300	353	22
14	350	480	30
16	400	627	39
18	450	793	50
20	500	979	61
24	600	1410	89
30	750	2203	139
36	900	3173	200
42	1050	4318	272
48	1200	5640	355
54	1350	7342	465
60	1500	8405	532

### Further References:

Perhaps the most easily accessible work on the subject of air entrapment in pipelines was a film produced in the late 1960's at Colorado State University. It was commissioned by a major pipe manufacturer and clearly shows the effect of air entrapment in pipelines and the importance of properly sizing and situating air release valves.

### Cyclic Design for PVC Pipes

Fatigue is a well known phenomenon that can affect many different materials. Only when a piping system is subjected to extreme cyclic loading conditions does fatigue in PVC pipe become a design factor. Fortunately, there has been a great deal of research done on this topic, and some recent research completed by Dr. A. Moser at Utah State University has contributed greatly to the understanding of this phenomenon.

Dr. Moser has determined that the number of cycles to failure (C) of PVC pipe is a function of the average stress in the pipe walls, as well as the amplitude of the cycles. This builds on previous work done by H.W. Vinson that based the cycles to failure only on the maximum stress in the material.

While cyclic loading is possible in many different applications, it is typically encountered in sewage forcemain and irrigation applications (Most water distribution mains or transmission mains have relatively constant pressures.) Any application that has pumps starting up and shutting down at regular intervals (ie more than a couple of times per day) should be analyzed using Dr. Moser's method.

The following graph shows how the average stress and the amplitude are related to the number of cycles to failure.

A worked example of a cyclic design for a sewage forcemain can be found in section 3.

Further Reading:

Vinson, H.W.: "Response of PVC Pipe to Large, Repetitive Pressure Surges" Proceedings of the International Conference on Underground Plastic Pipe (March 1981)

Moser, Folkman, Jeffrey: "Long-Term Cyclic Testing of 6 inch PVC Pipe" Utah State University, (March 2003)

### Cyclic Design for PVCO Pipes

Research has shown that PVCO pipe has more cyclic-fatigue resistance than PVC pipe does. However, the PVC-type design curves in Figure 3 have not been developed for PVCO.

The design approach recommended for PVCO pipe is to treat the PVCO pipe as PVC pipe of the same pressure class. Verify that the PVC pipe is adequate for the design conditions and then recognize that the actual PVCO pipe provides an additional safety factor against cyclic fatigue.

**Figure 3 – Resulting Cyclic-Failure Curves for PVC**

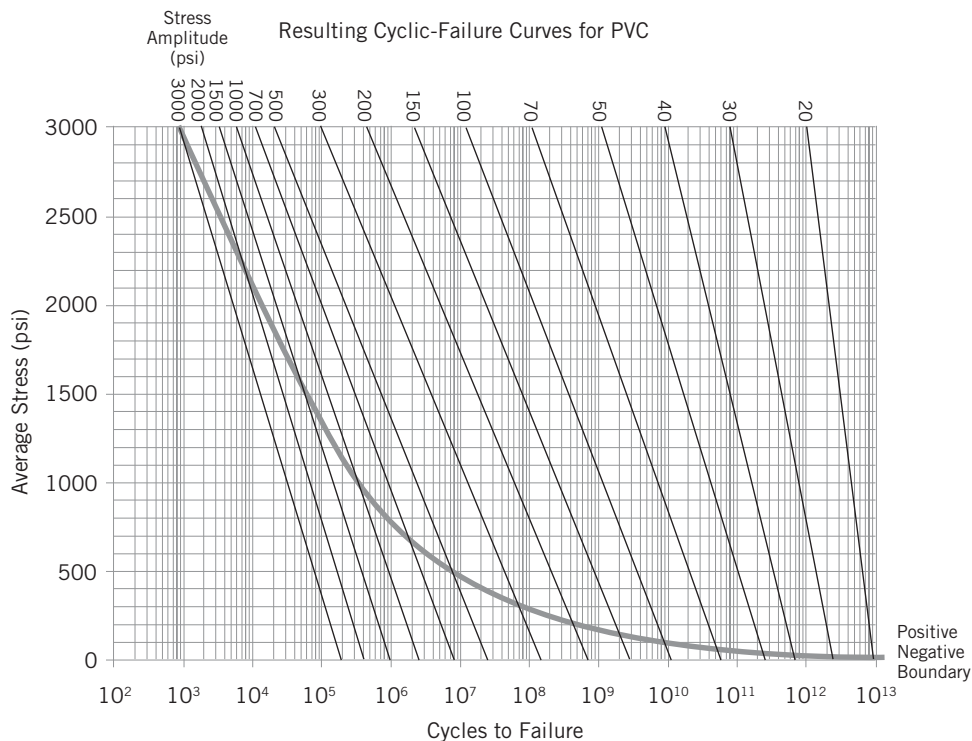

## Thrust Restraint in Gasketed Piping Systems

### Resisting Thrust at Fittings and Valves

At many locations in a pressurized pipeline, an imbalance in hydrostatic forces may occur as a result of the pipeline configuration. These unbalanced forces are called thrust forces. Thrust forces can occur at any point in a piping system where the direction or the cross-sectional area of the waterway changes. Pipeline installers must balance these forces by means of thrust blocks or mechanical restraint. Three areas that require restraint are described below.

- at valves

All valves must be anchored. This includes valves installed in a chamber or in line with the pipe, whether it is operated frequently or only once a year.

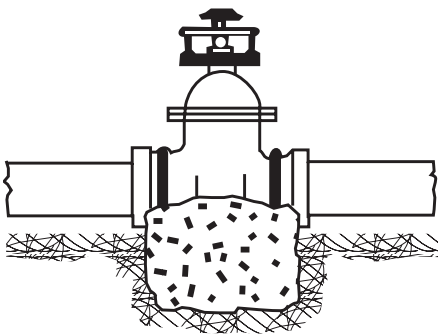

Install anchor rods around the valve body or through the mounting lugs and embed the rods in a concrete pour beneath the valve. Valves installed in chambers must also be anchored in this fashion. The critical time for restraint of valves is during opening or closing.

- at changes in direction (vertical or horizontal)

Fittings such as elbows, tees, or dead ends, must be restrained since they involve a significant directional change for the fluid.

- at reductions in size

The thrust component at reductions in size will depend on the amount of the reduction, and must be adequately restrained.

### Concrete Thrust Blocks

At each point in the line where thrust forces will develop, pour a concrete block between the fitting and undisturbed native soil at the side of the trench. Use plywood sheets to form the block and control the pour so that the area of contact with the undisturbed trench will provide the necessary support.

### Bearing Strength of Undisturbed Soils

Organic Material (such as Peat, etc.) . . . . .	0 psf
Soft Clay . . . . .	500 psf
Sand . . . . .	1000 psf
Sand and Gravel . . . . .	1500 psf
Sand & Gravel with Clay . . . . .	2000 psf
Sand & Gravel Cemented with Clay . . . . .	4000 psf
Hard Pan . . . . .	5000 psf

These soil bearing capacities are approximate and conservative. For greater design precision, IPEX recommends that soil bearing tests be carried out by a competent soils engineer.

The recommended bearing area to be established by the concrete pour may be given by the engineer. The area (ft.<sup>2</sup>) may also be calculated by determining the total thrust generated at the fitting. Simply divide the bearing strength of the soil into the thrust developed (lbs force), as found in the accompanying table. The result is the area of the soil required to resist the thrust (A). The area calculated will be for the area of concrete up against the trench wall (i.e. the back side of the block).

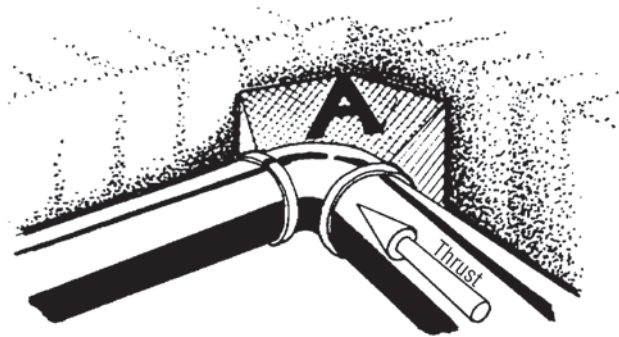

$$\text{area } A = \frac{\text{Thrust Force}}{\text{Bearing Strength of Soil}}$$



**Table 6 – Thrust Developed per 100 psi Pressure (lbs. force)**

Pipe Diameter		Valves & Dend Ends, Tees	90° Bends	45° Bends	22½° Bends	11¼° Bends
in	mm					
4	100	1810	2560	1390	635	320
6	150	3740	5290	2860	1370	690
8	200	6430	9100	4920	2320	1170
10	250	9680	13680	7410	3610	1820
12	300	13690	19350	10470	5080	2550
14	350	18380	25990	14100	6100	3080
16	400	23780	33630	18280	7960	4020
18	450	29860	42230	22970	10060	5080
20	500	36640	51820	28180	12440	6280
24	600	52280	73930	40200	17940	9060
30	750	80425	113737	61557	31500	15800
36	900	115200	162929	88181	45000	22600
42	1050	155500	219950	119000	60700	30500
48	1200	202700	286700	155200	79000	39800
54	1350	260100	367696	199059	101979	50985
60	1500	298000	421393	228056	116262	58412

Note: Pre-cast thrust blocks should not be placed directly against PVC fittings.

**Resisting Thrust in Very Poor Soils**

Where the pipeline passes through soils having little or no bearing strength, thrust forces may be restrained by the encasement of the fitting in concrete and the extension of this pour to form a monolith having sufficient inertia to resist the thrusts. It may also be possible to loop tie rods around the fitting and anchor the tie rods into an upstream concrete pour across the trench in more stable soils. Mechanical thrust restraints may also be used in these cases.

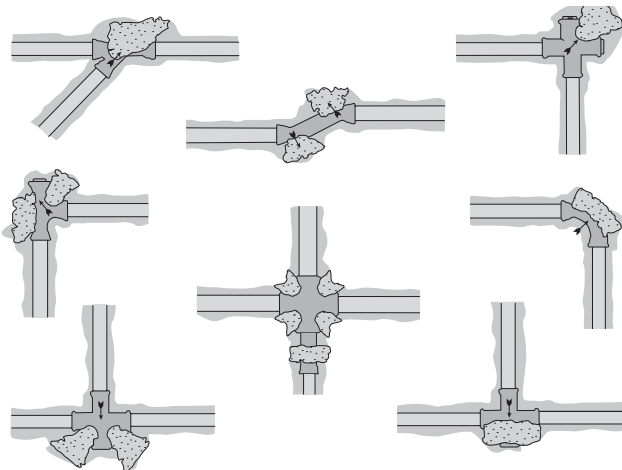

**Typical thrust block locations**

Trim the trench bearing area using hand tools to be sure of undisturbed soil.

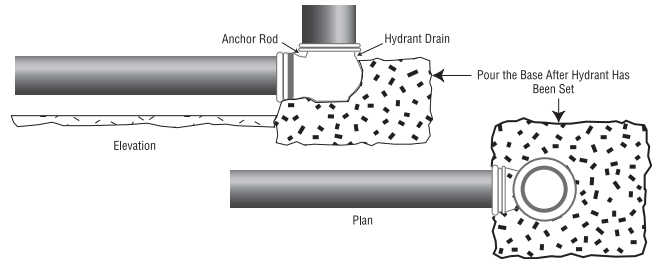

This type of hydrant foundation acts as a thrust block, as an anchorage against frost heave and eliminates washouts from wastewater drain.

**Resisting Vertical Thrust**

Where the pipeline will change direction downwards to pass under a creek bed or roadway, etc., upward thrust will be developed at the fitting. Anchor the fitting as though it were a valve, and ensure that the concrete base is keyed into undisturbed soil.

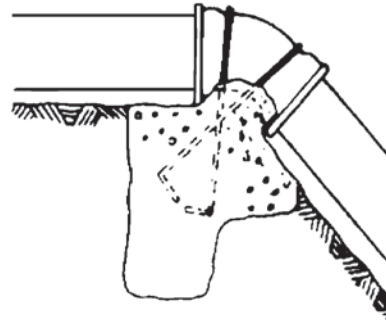

Straps should be 2 inches (50 mm) wide or greater.

### Holding Pipe to Steep Slopes

Normal bedding practices for pipelines installed up a hill will be sufficient to prevent backsliding and decoupling. When the height of cover is less than 6 feet (1.8 m), and the soil conditions are marginal, and where the slope is greater than 20° (36% slope), a special anchoring method may be desirable. One recommended procedure is to lay the pipe with the bells facing uphill and pour a concrete block behind the bells and keyed into the undisturbed trench sidewalls. Usually every third length of pipe will need to be anchored in this fashion to achieve a stable condition. The use of solvent welded joints for short sections of the pipeline may also be considered on steep slopes.

### Mechanical Thrust Restraints

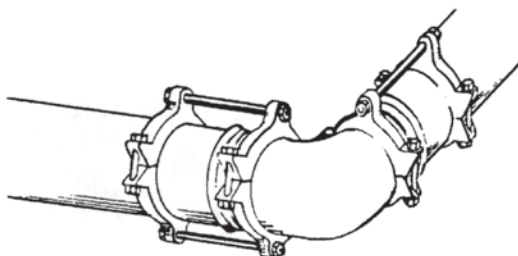

Several mechanical thrust restraint devices are available which clamp to the wall of the pipe and tie back to a mating collar on the fitting or the pipe bell. The use of these devices may provide the entire thrust restraint necessary at the fitting, in sizes up to 60 inches (1500 mm). The use of several thrust restraints to tie together two or three lengths of pipe on either side of the fitting may be desirable to enlist the clamping effect of the backfill around the pipe barrel.

When a thrust restraint device is used, the maximum pressure in the pipeline (usually the test pressure) must not exceed the pressure rating of the restraint device.

It is important to use restraints that are specifically tested and approved for use with PVC and/or PVCO pipe. Also, it is essential that the bolt-torque values provided by the restraint manufacturer be complied with by the installer.

### Assembly, Installation and testing of PVC Pressure Pipe Systems

Detailed information on how to install IPEX pressure pipes and fittings can be found in IPEX's Installation Guide for PVC Pressure Pipe and Fittings. This guide contains complete information on:

- Receiving and handling pipe shipments
- Trench preparation
- Lowering pipe into the trench
- Assembling joints
- Curvature of the pipeline.
- Assembling to valves and appurtenances
- Machining and chamfering the pipe
- Tapping, flanges and sleeves
- Outside diameter considerations
- Backfilling and installing bedding
- Pressure testing the pipeline
- Installing the pipeline through a casing
- Lubricant usage tables.

The Guide is available from your IPEX rep. or visit our technical library at [ipexna.com](http://ipexna.com).



## NOTES

## SECTION 3 – DESIGN EXAMPLES

### INTRODUCTIONS

Three design examples are presented in this section:

1. PVC sewage forcemain – this example shows the design method for a low-pressure line that is subjected to significant recurring surges. Cyclic fatigue controls the design.
2. Large-diameter PVC transmission line – this example illustrates the concept of changing the DR of the pipes in the pipeline as system pressures allow. Four different DRs are included.
3. High-velocity PVC pipeline experiencing extreme change in velocity. This line undergoes significant occasional surge pressure, but the ability of plastic pipe to withstand short-term loads means that occasional surge does not control the design.

#### Design Example #1: Sewage Forcemain – AWWA C900 PVC Pipe

Select the appropriate pipe size and pressure rating for a sewage forcemain with the following characteristics:

Peak Flow = 450 L/s (7130 gpm)

Elevation Change (static head): 30 meters (98 feet)

Length: 3000 meters (9850 feet)

Average pump cycles per day: 36

System peak pressure during controlled pump operations: 500 kPa (73 psi)

Minimum pressure during controlled pump operations: 200 kPa (29 psi)

Minimum design life: 50 years

#### Step 1 – Select an initial nominal pipe size and pressure rating

A maximum velocity of 1.5 m/s (5 ft/s) is typical in forcemain design.

$$Q = vA \therefore A = \frac{Q}{v}$$

Where,

A = required pipe cross sectional area, m<sup>2</sup>

v = fluid velocity, m/s

Q = Flow, m<sup>3</sup>/s

$$A = \frac{0.450 \text{ m}^3/\text{s}}{1.5 \text{ m/s}} = 0.3 \text{ m}_2$$

Required diameter:

$$a = \frac{\pi D^2}{4} \therefore D = \sqrt{\frac{4a}{\pi}} = \sqrt{\frac{4(0.3)}{\pi}} = 0.618 \text{ m} = 618 \text{ mm} \text{ is the required diameter}$$

Static pressure is 298 kPa (43 psi). Therefore select 600mm (24") nominal diameter SDR51 (pressure rated 80 psi) for initial calculations.

600mm SDR51 Inside Diameter = 630 mm (24.8").

Note: The purpose of these initial calculations is to select a nominal pipe size and pressure rating, so the required diameter numbers do not have to match. It is more important to select the proper pipe that corresponds with the initial system static head. This will give a basis for further calculations of dynamic head and surge pressures in the next steps

### Step 2 – Calculate dynamic head (friction and minor losses) and total system head

In this step the Hazen-Williams equation is used to calculate the friction losses in the system. For this example we will neglect the minor losses through fittings and valves. For systems with large numbers of fittings, the minor losses should be calculated as they can be significant. Note that the appropriate "C" factor for PVC pipe is 150.

Hazen-Williams Equation:

$$h_f = 10.654 \left( \frac{Q}{C} \right)^{1.54} \left( \frac{1}{D^{4.87}} \right) = 10.654 \left( \frac{0.450 \text{ m}^3/\text{s}}{150} \right)^{1.54} \left( \frac{1}{(0.630 \text{ m})^{4.87}} \right) 3000 \text{ m} = 6.5 \text{ m}$$

The headloss due to friction is 6.5 meters of head or 63 kPa (9 psi). This friction head is added to the static head to get the total system head. Note: When using the Hazen-Williams equation with imperial units use the proper imperial form of the equation shown in section 2.

$$h_{\text{sys}} = 30 \text{ m} + 6.5 \text{ m} = 36.5 \text{ m or } 358 \text{ kPa (52 psi)}$$

Therefore, SDR51 with a pressure rating (PR) of 80 psi is adequate for the working pressure requirements of this system.

### Step 3 – Calculate the short term (surge) requirements of the system

In section 2 a method to calculate the surge pressure for a given velocity change in a PVC pipe system was shown. The results of those calculations will be used here without reproducing the actual calculations again. To see exactly how these numbers were determined, refer to "Calculating Surge Pressures" in Section 2.

First calculate the actual maximum velocity of a 450 L/s flow in 600mm SDR51:

$$Q = v_a \therefore \frac{Q}{a} = \left( \frac{.450 \text{ m}^3/\text{s}}{\frac{\pi (0.630 \text{ m})^2}{4}} \right) = 1.44 \text{ m/s}$$

For every 0.3 m/s change in velocity, the surge pressure generated in SDR51 is 75 kPa (10.8psi).

$$P_s = \left( \frac{1.44 \text{ m/s}}{0.3} \right) 75 \text{ kPa} = 361 \text{ kPa (52.3 psi)}$$

From Section 2 – the short term rating (STR) of SDR51 is 880 kPa (128psi)

Short term requirements of the system: 358 kPa + 361 kPa = 719 kPa (104 psi)

In this case SDR51 is slightly under designed for the short term rating, so we reiterate the design using SDR41 with an STR of 130 psi. Since the I.D. is slightly different and the surge generated slightly higher – we re-calculate steps 1 to 3 to obtain the following results:

$$h_{\text{sys}} = 30 \text{ m} + 7.1 \text{ m} = 37.1 \text{ m or } 364 \text{ kPa (52.8 psi)}$$

$$P_s = \left( \frac{1.48 \text{ m/s}}{0.3} \right) 79 = 389 \text{ kPa (56.4 psi)}$$

**Short term requirements of the system: 364 kPa + 389 kPa = 753 kPa (109 psi)**

STR of SDR41 = 130 psi (>109 psi) therefore adequate for long-term and short-term requirements

#### Step 4 – Cyclic Analysis

Recent research by Dr. A. Moser at Utah State University with respect to cyclic fatigue in PVC pipes has both simplified and improved the accuracy of cyclic calculations. Note that the pressures used for the cyclic analysis are those that will occur during controlled start-up and shut down operations. The majority of today's pumping systems are equipped with soft start/stop capabilities, thus minimizing system shocks. The short-term system peak pressure (in this case 108 psi) is often not appropriate for cyclic analysis as it is the peak pressure that would be attained only during uncontrolled events (ie: a power outage), and is not cyclic in nature.

It was given that there are 36 cycles a day which means 36 startups and 36 shut downs for a total of 72 surge events per day.

Controlled max system pressure: 500 kPa (73 psi) {given}

Controlled minimum pressure: 200 kPa (29 psi) {given}

Calculate the average system stress:

$$\sigma_{avg} = \frac{(P_{max} + P_{min})(DR-1)}{4} = \frac{(500 \text{ kPa} + 200 \text{ kPa})(41-1)}{4} = 7000 \text{ kPa (1020 psi)}$$

Calculate the stress amplitude:

$$\sigma_{amp} = \frac{(P_{max} - P_{min})(DR-1)}{4} = \frac{(500 \text{ kPa} - 200 \text{ kPa})(41-1)}{4} = 3000 \text{ kPa (438 psi)}$$

Figure 3 – Resulting Cyclic-Failure Curves for PVC

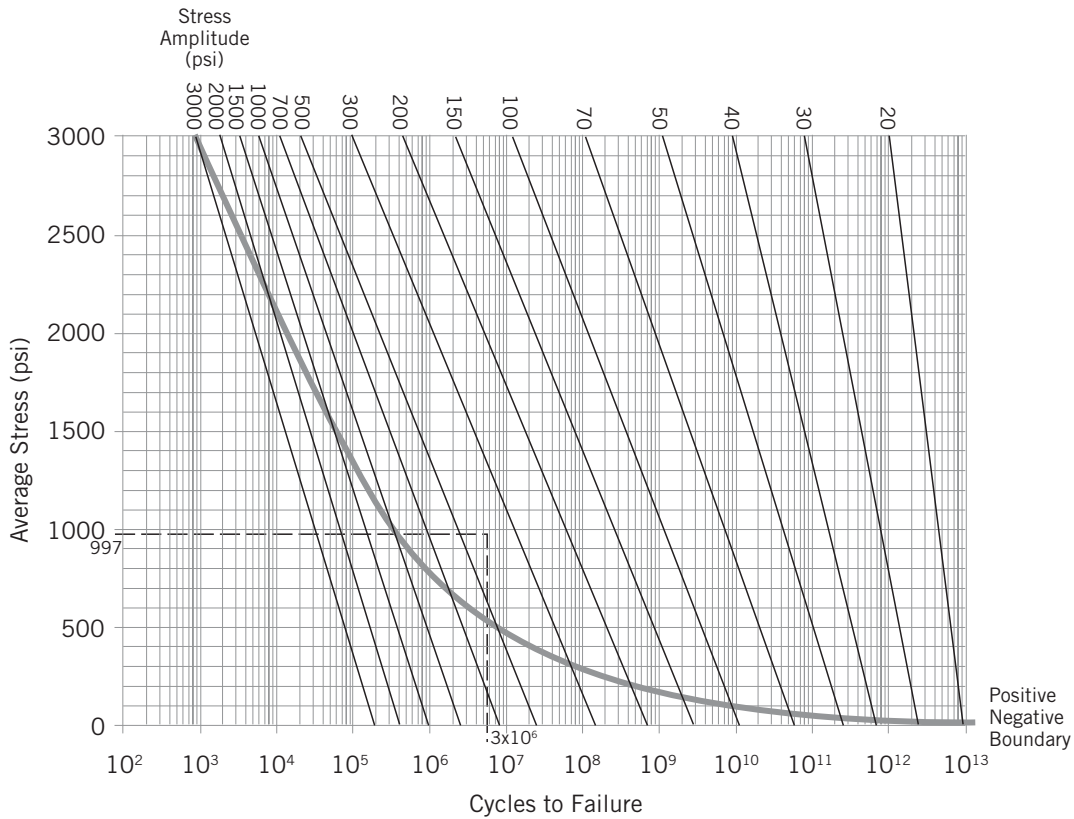

Determine the predicted number of cycles to failure using Moser’s curves. From the figure above, the predicted cycles to failure are roughly  $3 \times 10^6$  or 3,000,000 cyclic life pump starts/stops.

Calculate cyclic life:

Number of events: 72 per day  $\times$  365 days/year = 26,280 per year

Events to failure: 3,000,000

Cyclic life = 3,000,000/26280 = 152 years

Safety factor = 152 years / 100-year design life = 1.52 < 2.0 required

SDR51 is slightly under-designed for cyclic fatigue, so the next thicker pipe (SDR41) is analysed. Using the same method, the following results are obtained:

Average stress = 6 200 kPa (900 psi)

Stress amplitude = 2 200 kPa (320 psi)

Predicted cycles to failure are approximately 18,000,000.

Cyclic life = 680 years

This provides a safety factor against cyclic failure of 6.8, which exceeds the required safety factor of 2.0.

Therefore, SDR41 is adequate for the design conditions.

## Design Example #2: Sewage Forcemain – ASTM F1483 PVCO Bionax Pipe

Select the appropriate pipe size and pressure rating for a sewage forcemain with the following characteristics:

Peak Flow = 100 L/s (1590 gpm)

Static Pressure: 400 kPa (58 psi)

Length: 5000 meters (16400 feet)

Average pump cycles per day: 36

System peak pressure during controlled pump operations: 620 kPa (90 psi)

Minimum pressure during controlled pump operations: 180 kPa (26 psi)

Minimum design life: 100 years

### Step 1 – Select an initial nominal pipe size and pressure rating

A maximum velocity of 1.5 m/s (5 ft/s) is typical in forcemain design.

$$Q = vA \therefore A = \frac{Q}{v}$$

Where,

A = required pipe cross sectional area, m<sup>2</sup>

V = fluid velocity, m/s

Q = Flow, m<sup>3</sup>/s

$$A = \frac{0.100\text{m}^3/\text{s}}{1.5\text{m/s}} = 0.067\text{m}_2$$

Required diameter:

$$a = \frac{\pi D^2}{4} \therefore D = \sqrt{\frac{4a}{\pi}} = \sqrt{\frac{4(0.067)}{\pi}} = 0.291\text{m} = 291\text{mm} \text{ is the required diameter}$$

Static pressure is 400 kPa (58 psi). Therefore select 6300mm (12") nominal diameter PR160 (pressure rated 160 psi) for initial calculations.

300mm PR160 Inside Diameter = 309 mm (12.2").

**Note:** The purpose of these initial calculations is to select a nominal pipe size and pressure rating, so the required diameter numbers do not have to match. It is more important to select the proper pipe that corresponds with the initial system static head. This will give a basis for further calculations of dynamic head and surge pressures in the next steps

### Step 2 – Calculate dynamic head (friction and minor losses) and total system head

In this step the Hazen-Williams equation is used to calculate the friction losses in the system. For this example we will neglect the minor losses through fittings and valves. For systems with large numbers of fittings, the minor losses should be calculated as they can be significant. Note that the appropriate "C" factor for PVC pipe is 150.

Hazen-Williams Equation:

$$h_f = 10.654 \left( \frac{Q}{C} \right)^{0.54} \left( \frac{1}{D^{4.87}} \right) = 10.654 \left( \frac{0.100\text{m}^3/\text{s}}{150} \right)^{0.54} \left( \frac{1}{(0.309\text{m})^{4.87}} \right) 5000\text{m} = 21.3\text{m} = 209 \text{ kPa}$$

The loss due to friction is 209 kPa (30 psi). This friction head is added to the static head to get the total system head

**Note:** When using the Hazen-Williams equation with imperial units use the proper imperial form of the equation shown in section 2.

$$h_f = 400 \text{ kPa} + 209 \text{ kPa} = 609 \text{ kPa} (88 \text{ psi})$$

Therefore, PR160 Bionax pipe with a pressure rating (PR) of 160 psi is adequate for the working pressure requirements of this system.



### Step 3 – Calculate the short term (surge) requirements of the system

In section 2 a method to calculate the surge pressure for a given velocity change in a PVC pipe system was shown. The results of those calculations will be used here without reproducing the actual calculations again. To see exactly how these numbers were determined, refer to "Calculating Surge Pressures" in Section 2.

First calculate the actual maximum velocity of a 100 L/s flow in 300mm PR160:

$$Q = va \therefore \frac{Q}{a} = \left( \frac{.100\text{m}^3/\text{s}}{\frac{\pi(0.309\text{m})^2}{4}} \right) = 1.33\text{m/s}$$

For every 0.3 m/s change in velocity, the surge pressure generated in PR160 is 80 kPa (11.6 psi).

$$P_s = \left( \frac{1.33\text{m/s}}{0.3} \right) 80 \text{ kPa} = 356 \text{ kPa (51.6 psi)}$$

From Section 2 – the short term rating (STR) of PR160 is 1380 kPa (200psi)

Short term requirements of the system: 609 kPa + 356 kPa = 965 kPa (140 psi)

STR of PR160 = 200 psi (>140 psi) therefore adequate for long-term and short-term requirements

### Step 4 – Cyclic Analysis

Recent research by Dr. A. Moser at Utah State University with respect to cyclic fatigue in PVC pipes has both simplified and improved the accuracy of cyclic calculations. Note that the pressures used for the cyclic analysis are those that will occur during controlled start-up and shut down operations. The majority of today's pumping systems are equipped with soft start/stop capabilities, thus minimizing system shocks. The short-term system peak pressure (in this case 108 psi) is often not appropriate for cyclic analysis as it is the peak pressure that would be attained only during uncontrolled events (ie: a power outage), and is not cyclic in nature.

It was given that there are 36 cycles a day which means 36 startups and 36 shut downs for a total of 72 surge events per day.

Controlled max system pressure: 620 kPa (90 psi) {given}

Controlled minimum pressure: 180 kPa (26 psi) {given}

Calculate the average system stress:

$$\sigma_{\text{avg}} = \frac{(P_{\text{max}} + P_{\text{min}})(\text{DR}-1)}{4} = \frac{(620 \text{ kPa} + 180 \text{ kPa})(41-1)}{4} = 5000 \text{ kPa (729 psi)}$$

Calculate the stress amplitude:

$$\sigma_{\text{amp}} = \frac{(P_{\text{max}} - P_{\text{min}})(\text{DR}-1)}{4} = \frac{(620 \text{ kPa} - 180 \text{ kPa})(41-1)}{4} = 2750 \text{ kPa (401 psi)}$$

Figure 3 – Resulting Cyclic-Failure Curves for PVC

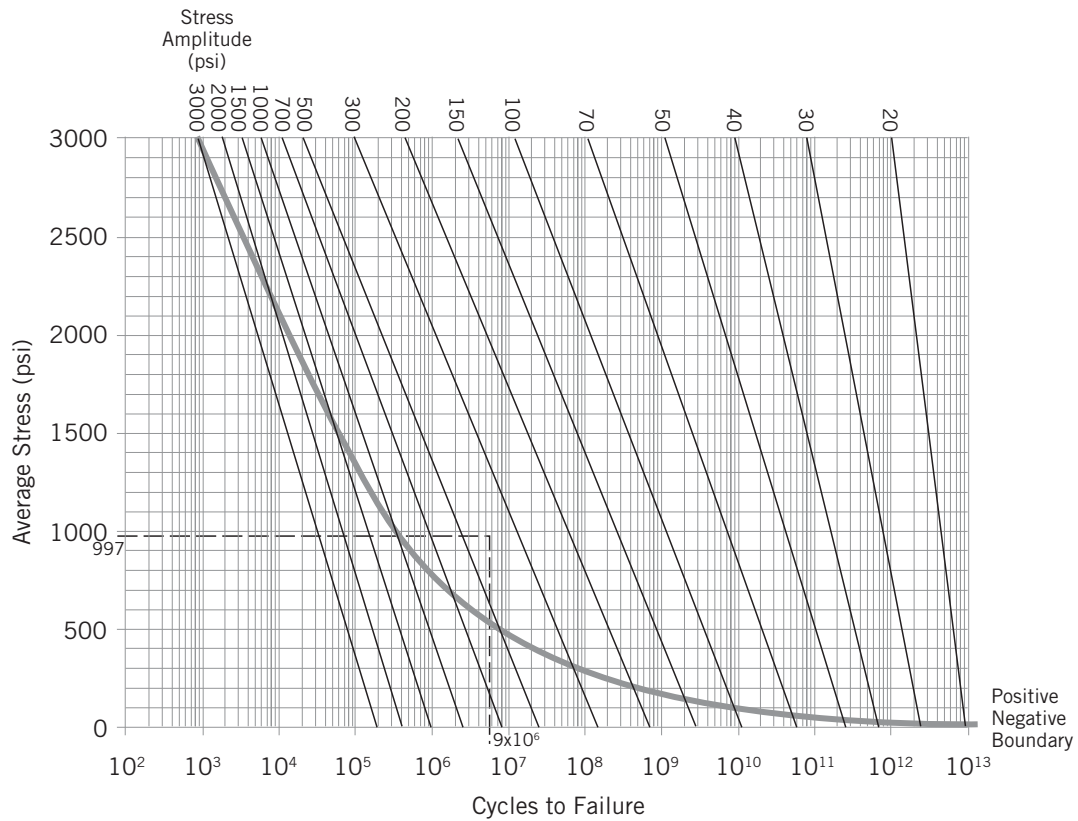

Determine the predicted number of cycles to failure using Moser's plot.

From the plot, the predicted cycles to failure are roughly  $9 \times 10^6$  pump starts and stops

Calculate cyclic life:

72 events per day  $\times$  365 = 26,280 events per year

$9 \times 10^6 / 26280 = 342$  years

Therefore, SDR41 is more than adequate for the application.

### Design Example #3: Transmission Pipe *(Taken from AWWA M23 – PVC Pipe Design & Installation Manual)*

This analysis of a relatively simple pipeline will illustrate the use of the design principles discussed in this guide section. PVC pipe standards offer a variety of pipe strengths and sizes. Ideally, the designer will make selections that minimize capital and operating costs while maintaining an adequate design safety factor.

The project is a 20,000' long PVC water transmission main designed for an ultimate capacity of 4,000 gpm (5.76 mgd).

The profile of the pipeline is shown below. Water is being pumped to a ground storage tank (point f) with a maximum water level of 35' from the floor. The centerline of the discharge end of the main, at the tie-in to the storage tank, will be 5' below the tank floor.

Key stations and their elevations along the pipeline are:

Point	Station	Elevation at Pipe Centerline (ft)
a	0 + 00	600
b	45 + 00	670
c	75 + 00	720
d	115 + 00	800
e	165 + 00	940
f	200 + 00	940

Figure 4 – Pipeline Profile

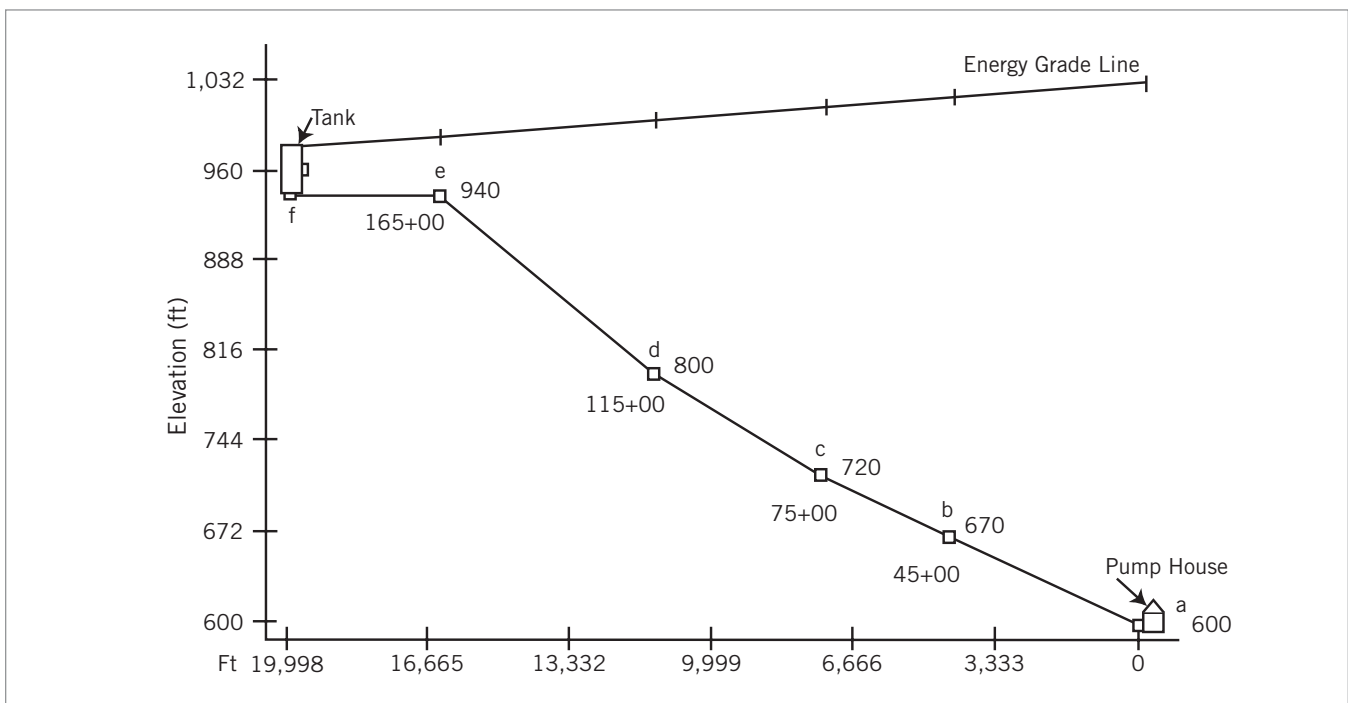

The objective of the design process will be to select proper DRs of PVC for appropriate sections of pipeline while never exceeding the PR nor the WPR of the pipe at any point. An effort will be made to select DRs that meet the design criteria while providing optimum economic value for the utility or owner.

The key determinant of PVC pressure pipe design is the internal pressure. The pipe dimensions can be found in the AWWA pipe standards. For this example, AWWA Standard C900, *Polyvinyl Chloride (PVC) Pressure Pipe and Fabricated Fittings, 4 In. through 60 In. (100mm through 1,500mm), for Water Transmission and Distribution*, was used. The exact pipe dimensions are required to determine the flow velocity. The total pressure in the pipeline at any point is the sum of the static head, the friction loss, and the pressure rise as a result of sudden velocity changes. For simplicity, the selection of PVC pipe in this example will be limited to four PRs in CIOD only (PR 235, 165, 125 and 100).

**Step 1 – Determine the maximum flow velocity**

Assume that 20" PVC pipe will be used. In AWWA C900, the heaviest wall shown to be available in 20" pipe is DR 18. The assumption of beginning with the heaviest wall (i.e., the lowest DR) is recommended for most designs in the initial stage. The first assumption may be confirmed or revised as the design is developed.

$$\text{Average ID} = \text{Average OD} - 2 (\text{minimum wall thickness} \times 1.06)$$

Note: The tolerance on wall thickness is approximately +12%. There is no minus tolerance. Manufacturers will generally aim to produce PVC pressure pipe with wall thicknesses about 6% over minimum.

Assume: 20" DR 18 per AWWA C900

$$\begin{aligned} \text{Avg. ID} &= 21.60 - 2 (1.200 \times 1.06) \\ &= 19.05 \text{ in} = 1.59 \text{ ft} \end{aligned}$$

$$V = Q/A$$

Where,

$$Q = \text{Flow in ft}^3/\text{sec} = 4,000 \text{ gpm or } 8.91 \text{ ft}^3/\text{sec}$$

$$A = \text{area, ft}^2$$

$$V = \text{velocity, ft/sec}$$

$$A = (3.14) (1.59/2)^2 = 1.98 \text{ ft}^2$$

Therefore,

$$V = 8.91/1.98 = 4.5 \text{ ft/sec}$$

Because the velocity is within an acceptable range, the design may proceed with 20" pipe.

**Step 2 – Determine the surge factor**

In a transmission pipeline, the amplitude and location of the surge pressure envelope will often be analyzed by computer. For this example, the assumption has been made that the maximum surge pressure will be equal to an instantaneous stop-page of flow at full velocity. In practice, the costs of pipe materials may be significantly reduced through the use of appropriate surge control devices and proper pipeline operating procedures.

The pressure rise resulting from a  $V = 4.5 \text{ ft/sec}$  instantaneous velocity change in PVC pressure pipes can be charted as follows:

Dimension Ratio, DR	1 ft/sec Surge, $P_s'$ (psi)	$V \times P_s'$ (psi)
41	11.4	51.3
32.5	12.8	57.6
25	14.7	66.2
18	17.4	78.3

### Step 3 – Determine the WPR for each of the DRs of Step 2

The WPR is a job-specific pressure rating of the pipe, taking into account the maximum possible surges versus the short-term strength of the pipe. The WPR may be either higher or lower than the PR of the pipe, depending on the flow conditions. The lower value between the WPR and the PR should be used as the upper limit for system steady-state operating pressure.

$$WPR = STR - V \times P_s'$$

DR	STR (psi)	V x P <sub>s</sub> ' (psi)	WPR (psi)	PR (psi)
41	130	51.3	78.7	100
32.5	165	57.6	107.4	125
25	215	66.2	148.8	165
18	300	78.3	221.7	235

It can be seen that the governing parameter for the pressure design of this example will be the WPR analysis since it is lower than the PR of each DR.

### Step 4 – Determine the friction loss f under full-flow conditions

Continue to assume DR 18 for this calculation because this pipe will produce slightly greater losses than the other DRs under consideration. The result will be conservative for all design operations.

The Hazen-Williams equation is convenient to use:

$$f = 0.2083 (100/C)^{1.852} \frac{Q^{1.852}}{d_i^{4.8655}}$$

Where,

f = friction head, ft of water per 100 ft of pipe

d<sub>i</sub> = inside diameter of pipe, in.

Q = flow, gpm

C = flow coefficient, 150 for PVC

Substituting for 20" PR 235 pipe, where d = 19.05 in

f = 0.273 ft of water per 100 ft of pipeline

= 0.118 psi per 100 ft (station) of pipeline

### Step 5 – Determine the pressures at key points in the pipeline under steady-state, full-flow conditions

This pressure, P, at any point is the sum of the static head as a result of difference in elevations and the friction loss.

Referring to Figure 4, the pressure at key points can be calculated as follows:

Starting at the storage tank:

<b>Station 200 + 00</b>				
Static Head	=	980 – 940	=	40 ft
or 40 ft x (0.43 psi/ft)			=	17.3 psi
<b>Station 165 + 00</b>				
Static Head	=	(980 – 940) ft x (0.43 psi/ft)	=	17.3 psi
Friction Head	=	(3,500 ft) x (0.118 psi/100 ft)	=	4.1 psi
Total Head			=	21.4 psi
<b>Station 115 + 00</b>				
Static Head	=	(980 – 800) ft x (0.43 psi/ft)	=	77.4 psi
Friction Head	=	(8,500 ft) x (0.118 psi/100 ft)	=	10.0 psi
Total Head			=	87.4 psi
<b>Station 75 + 00</b>				
Static Head	=	(980 – 720) ft x (0.43 psi/ft)	=	111.8 psi
Friction Head	=	(12,500 ft) x (0.118 psi/100 ft)	=	14.8 psi
Total Head			=	126.6 psi
<b>Station 45 + 00</b>				
Static Head	=	(980 – 670) ft x (0.43 psi/ft)	=	133.3 psi
Friction Head	=	(15,500 ft) x (0.118 psi/100 ft)	=	18.3 psi
Total Head			=	151.6 psi
<b>Station 0 + 00</b>				
Static Head	=	(980 – 600) ft x (0.43 psi/ft)	=	163.4 psi
Friction Head	=	(20,000 ft) x (0.118 psi/100 ft)	=	23.6 psi
Total Head			=	187.0 psi

The pressure, P, at each of the key points are summarized as follows:

Point	Station	Static Head (psi)	Friction Head (psi)	Pressure, P (psi)
f	200 + 00	17.3	0	17.3
e	165 + 00	17.3	4.1	21.4
d	115 + 00	77.4	10.0	87.4
c	75 + 00	111.8	14.8	126.6
b	45 + 00	133.3	18.3	151.6
a	0 + 00	163.4	23.6	187.0

### Step 6 – Determine the appropriate DR of pipe for each section of the pipeline

From previous calculations in Step 3, DR 18 PVC pressure pipe has a working pressure rating 221.7 psi. For the next greater DR, DR 25, the WPR is 148.8 psi. Therefore, DR 18 is selected to start out at the pumphouse until a point in the system where the operating pressure, P, drops to be equal to the WPR of DR 25. At this point, DR 25 may be used. Subsequent steps will determine the starting points for DR 32.5 as well as DR 41.

It can be seen from the above summary of pressures by section that the transition to DR 25 will occur between Stations 45 + 00 and 75 + 00, in section bc. To pinpoint the exact location, the pressure gradient for that section must be calculated.

$$\begin{aligned}\Delta P(bc) &= \frac{(P_c + P_b)}{\text{Station Length of bc}} \\ &= \frac{126.6 \text{ psi} - 151.6 \text{ psi}}{(75 - 45) \times (100 \text{ ft})} \\ &= -0.83 \text{ psi}/100 \text{ ft}\end{aligned}$$

The length beyond Station 45 + 00 (point b) can be calculated as follows:

$$\begin{aligned}\text{Station Length} &= \frac{\text{WPR}(\text{DR } 25) - P_b}{\Delta P(bc)} \\ &= \frac{(148.8 \text{ psi}) - (151.6 \text{ psi})}{-0.83 \text{ psi}/100 \text{ ft}} \\ &= 337 \text{ ft (i.e., at 337 ft downstream of Station 45 + 00)}\end{aligned}$$

Therefore, begin using DR 25 at Station 48 + 37.

Similarly, the transition point for DR 32.5 can be found.

From the summary of pressures and knowing the WPR of DR 32.5 is 107.4 psi, DR 32.5 can be used between Station 75 + 00 and Station 115 + 00, i.e., section cd.

First, calculate the pressure gradient in section cd.

$$\begin{aligned}\Delta P(cd) &= \frac{(P_d - P_c)}{\text{Station Length of cd}} \\ &= \frac{87.4 \text{ psi} - 126.6 \text{ psi}}{(115 - 75) \times (100 \text{ ft})} \\ &= -0.98 \text{ psi}/100 \text{ ft}\end{aligned}$$

Next, the Station Length beyond Station 75 + 00 can be calculated:

$$\begin{aligned}\text{Station Length} &= \frac{\text{WPR}(\text{DR } 32.5) - P_c}{\Delta P(cd)} \\ &= \frac{(107.4 \text{ psi}) - (126.6 \text{ psi})}{-0.98 \text{ psi}/100 \text{ ft}} \\ &= 1,959 \text{ ft (i.e., at 1,959 ft downstream of Station 75 + 00)}\end{aligned}$$

Therefore, begin using DR 32.5 at Station 94 + 59.

Similarly, it can be calculated where DR 41 usage may begin.

From review of the summary of pressures and knowing the WPR of DR 41 is 78.7 psi, the range for DR 41 begins between Station 115 + 00 and Station 165 + 00, i.e., section de.

First, calculate the pressure gradient in section de.

$$\begin{aligned} \Delta P(\text{de}) &= \frac{(P_e - P_d)}{\text{Station Length of de}} \\ &= \frac{21.4 \text{ psi} - 87.4 \text{ psi}}{(165 - 115) \times (100 \text{ ft})} \\ &= -1.32 \text{ psi}/100 \text{ ft} \end{aligned}$$

Next, the Station Length beyond point d:

$$\begin{aligned} \text{Station Length} &= \frac{\text{WPR}(\text{DR 41}) - P_d}{\Delta P(\text{de})} \\ &= \frac{(78.7 \text{ psi}) - (87.4 \text{ psi})}{-1.32 \text{ psi}/100 \text{ ft}} \\ &= 659 \text{ ft (i.e., at 659 ft downstream of Station 115 + 00)} \end{aligned}$$

Therefore, DR 41 may begin usage at Station 121 + 59 and continue for the duration of the pipeline up to its terminus at the reservoir.

Distance from Pumphouse (ft)	Use 20 in.	Pressure Gradient (psi)
0 – 4,837	DR 18 (PR 235)	187.0 – 148.8
4,837 – 9,459	DR 25 (PR 165)	148.8 – 107.4
9,459 – 12,159	DR 32.5 (PR 125)	107.4 – 78.7
12,159 – 20,000	DR 41 (PR 100)	78.7 – 17.3

The design for internal pressure may be summarized as follows:

In this example of a 3.8 mile pipeline, the designer has the opportunity to make significant cost savings through the use of several PVC pipe pressure ratings. Computer modeling may disclose even further potential savings by showing exactly where and how surge control is most effective. (Note that the above pipe selection was made assuming that the potential exists for the instantaneous stoppage of flow.)

If the pipeline is operated in a cycle mode (i.e., like some sewage force mains), an analysis of fatigue life should be made. Both present and future modes of operation should be examined.



## NOTES

## SECTION FOUR: APPENDICES

### APPENDIX A: REFERENCES

- 1 Duranceau, Schiff, Bell. "Electrical Grounding, Pipe Integrity and Shock Hazard", Journal of the AWWA, July 1998, pp. 40-51
- 2 Hulsmann, Nowack, "70 Years of Experience with PVC Pipes" Conference Paper, Plastic Pipes XII, Milan, April 2004
- 3 Jenkins, Thompson, "Review of Water Industry Plastic Pipe Practices", AWWA Research Foundation, 1987
- 4 Berens, A.R., "Prediction of Chemical Permeation through PVC Pipe", Journal of the AWWA, November 1985
- 5 Hoogensen Metallurgical Engineering Ltd., "Examination of Submitted PVC Pipe Section", Report to IPEX, December 1998
- 6 Uni-Bell PVC Pipe Association, "Handbook of PVC Pipe – Design and Construction", fourth edition, (August 2001)

## APPENDIX B: REFERENCE TABLES AND CONVERSION CHARTS

Table B-1 Pipe Capacity

Table B-2 Weights of Water

Table B-3 Decimal & Millimeter Equivalents of Fractions

Table B-4 Volume Conversion

Table B-5 Pressure Conversion

Table B-6 Flow Conversion

Table B-7 Temperature Conversion

Table B-8 Length Conversion

### TABLE B-1 PIPE CAPACITY

Pipe Size inches	Outside Diameter – IPS OD Pipe			Volume for 1 foot length of pipe				
	inch	feet	cm	in <sup>3</sup>	ft <sup>3</sup>	cm <sup>3</sup>	US Gal	Imp Gal
1/4	0.250	0.021	0.098	0.589	0.0003	9.648	0.003	0.002
3/8	0.375	0.031	0.148	1.325	0.001	21.708	0.006	0.005
1/2	0.500	0.042	0.197	2.355	0.001	38.591	0.010	0.008
3/4	0.750	0.063	0.295	5.299	0.003	86.831	0.023	0.019
1	1.000	0.083	0.394	9.420	0.005	154.366	0.041	0.034
1-1/4	1.250	0.104	0.492	14.719	0.009	241.196	0.064	0.053
1-1/2	1.500	0.125	0.591	21.195	0.012	347.322	0.092	0.076
2	2.000	0.167	0.787	37.680	0.022	617.462	0.163	0.136
3	3.000	0.250	1.181	84.780	0.049	1,389.290	0.367	0.306
4	4.000	0.333	1.575	150.720	0.087	2,469.849	0.652	0.543
5	5.000	0.417	1.969	235.500	0.136	3,859.139	1.019	0.849
6	6.000	0.500	2.362	339.120	0.196	5,557.159	1.468	1.222
8	8.000	0.667	3.150	602.880	0.349	9,879.395	2.610	2.173
10	10.000	0.833	3.937	942.000	0.545	15,436.554	4.078	3.396
12	12.000	1.000	4.724	1,356.480	0.785	22,228.638	5.872	4.890
14	14.000	1.167	5.512	1,846.320	1.068	30,255.646	7.993	6.655
16	16.000	1.333	6.299	2,411.520	1.396	39,517.578	10.439	8.693
18	18.000	1.500	7.087	3,052.080	1.766	50,014.435	13.212	11.002
20	20.000	1.667	7.874	3,768.000	2.181	61,746.216	16.312	13.582
24	24.000	2.000	9.449	5,425.920	3.140	88,914.551	23.489	19.559

### TABLE B-2 WEIGHTS OF WATER

Units of Volume	Weight	
	pounds	kilograms
1 US Gallon	8.35	3.79
1 Imperial Gallon	10.02	4.55
1 litre	2.21	1.00
1 cubic yard	1,685.610	765.267
1 cubic foot	62.430	28.343
1 cubic inch	0.036	0.016
1 cubic cm	0.002	0.001
1 cubic metre	2,210.000	1,000.000

**TABLE B-3 DECIMAL & MILLIMETER EQUIVALENTS OF FRACTIONS**

Inches Fractions	Decimals	Millimeters	Inches Fractions	Decimals	Millimeters
1/64	0.015625	0.397	33/64	0.515625	13.097
1/32	0.03125	0.794	17/32	0.53125	13.494
3/64	0.046875	1.191	35/64	0.546875	13.891
1/16	0.0625	1.588	9/16	0.5625	14.288
5/64	0.078125	1.984	37/64	0.578125	14.684
3/32	0.09375	2.381	19/32	0.59375	15.081
7/64	0.109375	2.778	39/64	0.609375	15.478
1/8	0.125	3.175	5/8	0.625	15.875
9/64	0.140625	3.572	41/64	0.640625	16.272
5/32	0.15625	3.969	21/32	0.65625	16.669
11/64	0.171875	4.366	43/64	0.671875	17.066
3/16	0.1875	4.763	11/16	0.6875	17.463
13/64	0.203125	5.159	45/64	0.703125	17.859
7/32	0.21875	5.556	23/32	0.71875	18.256
15/64	0.234375	5.953	47/64	0.734375	18.653
1/4	0.250	6.350	3/4	0.750	19.050
17/64	0.265625	6.747	49/64	0.765625	19.447
9/32	0.28125	7.144	25/32	0.78125	19.844
19/64	0.296875	7.541	51/64	0.796875	20.241
5/16	0.3125	7.938	13/16	0.8125	20.638
21/64	0.328125	8.334	53/64	0.828125	21.034
11/32	0.34375	8.731	27/32	0.83475	21.431
23/64	0.359375	9.128	55/64	0.859375	21.828
3/8	0.375	9.525	7/8	0.875	22.225
25/64	0.390625	9.922	57/64	0.890625	22.622
13/32	0.40625	10.319	29/32	0.90625	23.019
27/64	0.421875	10.716	59/64	0.921875	23.416
7/16	0.4375	11.113	15/16	0.9375	23.813
29/64	0.453125	11.509	61/64	0.953125	24.209
15/32	0.46875	11.906	31/32	0.96875	24.606
31/64	0.484375	12.303	63/64	0.984375	25.003
1/2	0.500	12.700	1	1.000	25.400

**TABLE B-4 VOLUME CONVERSION**

Units of Volume	in <sup>3</sup>	ft <sup>3</sup>	yd <sup>3</sup>	cm <sup>3</sup>	m <sup>3</sup>	liter	U.S. gal.	Imp. gal.
cubic inch	1	0.00058	-	16.387	-	0.0164	0.0043	0.0036
cubic foot	1728	1	0.0370	28,317.8	0.0283	28.32	7.481	6.229
cubic yard	46,656	27	1	-	0.7646	764.55	201.97	168.8
cubic centimeter	0.0610	-	-	1	-	0.001	0.0003	0.0002
cubic meter	61,023.7	35.31	1.308	-	1	1000	264.17	220.0
liter	61.02	0.0353	0.0013	1000	0.001	1	0.2642	0.22
U.S. gallon	231	0.1337	0.0050	3785.4	0.0038	3.785	1	0.8327
Imp. gallon	277.42	0.1605	0.0059	4546.1	0.0045	4.546	1.201	1

**TABLE B-5 PRESSURE CONVERSION**

Units of Pressure	atm	bar	lb/in <sup>2</sup>	lb/ft <sup>2</sup>	kg/cm <sup>2</sup>	kg/m <sup>2</sup>	inch H <sub>2</sub> O
atmosphere (atm)	1	0.987	0.068	-	0.968	-	0.002
bar	1.013	1	0.069	-	0.981	-	0.002
pound per square inch (psi)	14.7	14.5	1	0.007	14.22	0.001	0.036
pound per square foot (psf)	2,116	2,089	144	1	2,048	0.205	5.2
kilogram per square centimeter	1.033	1.02	0.07	-	1	0.0001	0.003
kilogram per square meter	10,332	10,197	703	4.88	10,000	1	25.4
inch of water (H <sub>2</sub> O) (4°C)	406.78	401.46	27.68	0.192	393.7	0.039	1
inch of mercury (Hg) (0°C)	29.921	29.53	2.036	0.014	28.96	0.003	0.074
inch of air (15°C)	332,005	327,664	22,592	148.7	321,328	32.13	816.2
foot of water (4°C)	33.9	33.46	2.307	0.016	32.81	0.003	0.083
foot of air (15°C)	27,677	27,305	1,883	13.07	26,777	2.678	0.006
millimeter of mercury (0°C)	760	750	51.71	0.36	735.6	0.074	1.868
millimeter of water (4°C)	10,332	10,197	703	4.88	10,000	1	25.4
kilopascal (kP)	101.3	100	6.89	0.048	98.07	0.01	0.249
Newton per square meter	-	-	-	0.021	-	0.102	0.004

Units of Pressure	inch Hg	inch air	ft H <sub>2</sub> O	ft air	mm Hg	mm H <sub>2</sub> O	kilopascal	N/m <sup>2</sup>
atmosphere (atm)	0.033	-	0.029	-	0.001	-	0.01	-
bar	0.034	-	0.03	-	0.001	-	0.01	-
pound per square inch (psi)	0.491	-	0.434	0.001	0.019	0.001	0.145	-
pound per square foot (psf)	70.73	0.006	62.43	0.076	2.784	0.205	20.89	0.021
kilogram per square centimeter	0.035	-	0.03	-	0.001	-	0.01	-
kilogram per square meter	345.3	0.031	304.8	0.373	13.6	1	101.97	0.102
inch of water (H <sub>2</sub> O) (4°C)	13.6	0.001	12	0.015	0.535	0.039	4.015	0.004
inch of mercury (Hg) (0°C)	1	-	0.883	0.001	0.039	0.003	0.295	-
inch of air (15°C)	11,096	1	9,794	12	436.8	32.13	3,277	3.106
foot of water (4°C)	1.133	-	1	-	0.045	0.003	0.335	-
foot of air (15°C)	924.7	0.083	816.2	1	36.4	2.678	273.1	0.273
millimeter of mercury (0°C)	25.4	0.002	22.42	0.027	1	0.074	7.5	0.008
millimeter of water (4°C)	345.3	0.031	304.8	0.373	13.6	1	101.97	0.102
kilopascal (kP)	3.386	-	2.99	0.004	0.133	0.01	1	0.001
Newton per square meter	-	3.277	-	0.273	0.008	0.102	0.001	1

**TABLE B-6 FLOW CONVERSION**

Units of Flow Rate	US gps	US gpm	US gph	US gpd	Imp gps	Imp gpm	Imp gph	Imp gpd	liters/sec	liters/min	liters/hr	liters/day
US gal/sec (gps)	1	0.017	-	-	1.2	0.02	-	-	0.264	0.004	-	-
US gal/min (gpm)	60	1	0.017	0.001	72.06	1.2	0.02	0.001	15.85	0.264	0.004	-
US gal/hr (gph)	3,600	60	1	0.042	4,323	72.06	1.2	0.05	951.02	15.85	0.264	0.011
US gal/day (gpd)	86,400	1,440	24	1	103,762	1,729.40	28.82	1.2	22,824	380.41	6.34	0.264
Imperial gal/sec	0.833	0.014	-	-	1	0.017	-	-	0.22	0.004	-	-
Imperial gal/min	49.96	0.833	0.014	0.001	60	1	0.017	0.001	13.2	0.22	0.004	-
Imperial gal/hr	2,997.60	49.96	0.833	0.035	3,600	60	1	0.042	791.89	13.2	0.22	0.009
Imperial gal/day	71,943	1,199	19.98	0.833	86,400	1,440	24	1	19,005	316.76	5.279	0.22
Liters/sec	3.79	0.063	0.002	-	4.55	0.076	0.001	-	1	0.017	-	-
Liters/min	227.12	3.785	0.063	0.003	272.77	4.55	0.076	0.003	60	1	0.017	0.001
Liters/hr	13,627	227.12	3.785	0.158	16,366	272.77	4.55	0.189	3,600	60	1	0.042
Liters/day	327,060	5,451	90.85	3.785	392,782	6,546	109.11	4.55	86,400	1,440	24	1
Cubic ft/sec (cfs)	0.134	0.002	-	-	0.161	0.003	-	-	0.035	0.001	-	-
Cubic ft/min (cfm)	8.02	0.134	0.002	-	9.633	0.161	0.003	-	2.119	0.035	0.001	-
Cubic ft/hr (cfh)	481.25	8.02	0.134	0.006	577.96	9.63	0.161	0.007	127.13	2.119	0.035	0.001
Cubic ft/day (cfd)	11,550	192.5	3.21	0.134	13,871	231.18	3.853	0.161	3,051.20	50.85	0.848	0.001
Acre in/min	0.002	-	-	-	0.003	-	-	-	0.001	-	-	-
Acre in/hr	0.133	0.002	-	-	0.159	0.003	-	-	0.035	-	-	-
Acre in/day	3.182	0.053	0.001	-	3.821	0.064	0.001	-	0.841	0.001	-	-
Cubic m/sec	0.004	-	-	-	0.005	-	-	-	0.001	-	-	-
Cubic m/min	0.227	0.004	-	-	0.273	0.005	-	-	0.06	0.001	-	-
Cubic m/hr	13.628	0.227	0.004	-	16.366	0.273	0.005	-	3.6	0.06	0.001	-
Cubic m/day	327.06	5.451	0.091	0.004	392.78	6.546	0.109	0.005	86.4	1.44	0.024	0.001

Units of Flow Rate	ft³/sec	ft³/min	ft³/hr	ft³/day	Acre in/min	Acre in/hr	Acre in/day	m³/sec	m³/min	m³/hr	m³/day
US gal/sec (gps)	7.48	0.125	0.002	-	452.6	7.54	0.31	264.2	4.4	0.073	0.003
US gal/min (gpm)	448.8	7.48	0.125	0.005	27,154	452.6	18.86	15,850	264.2	4.403	0.183
US gal/hr (gph)	26,930	448.83	7.481	0.312	1.629E+06	27,154	1,131	951,019	15,850	264.17	11.007
US gal/day (gpd)	646,317	10,772	179.53	7.481	3.910E+07	651,703	27,154	2.282E+07	380,408	6,340	264.17
Imperial gal/sec	6.229	0.104	0.002	-	376.8	6.28	0.26	220	3.67	0.061	0.003
Imperial gal/min	373.73	6.229	0.104	0.004	22,611	376.8	15.7	13,198	220	3.666	0.153
Imperial gal/hr	22,424	373.73	6.229	0.259	1.357E+06	22,611	942.1	791,889	13,198	220	9.165
Imperial gal/day	538,171	8,970	149.49	6.229	3.256E+07	542,656	22,611	1.901E+07	316,756	5,279	220
Liters/sec	28.32	0.472	0.008	-	1,713	28.6	1.19	1,000	16.67	0.278	0.012
Liters/min	1,699	28.32	0.472	0.2	102,790	1,713	71.38	60,000	1,000	16.67	0.694
Liters/hr	101,941	1,669	28.32	1.18	6.167E+06	102,790	4,283	3.600E+06	60,000	1,000	42.67
Liters/day	2,446,575	40,776	679.6	28.32	1.480E+08	2.467E+06	102,790	8.640E+07	1.440E+06	24,000	1,000
Cubic ft/sec (cfs)	1	0.017	-	-	60.5	1.008	0.042	35.31	0.589	0.01	-
Cubic ft/min (cfm)	60	1	0.017	-	3,630	60.5	2.52	2,119	35.31	0.59	0.025
Cubic ft/hr (cfh)	3,600	60	1	0.042	217,800	3,630	151.25	127,133	2,119	35.31	1.471
Cubic ft/day (cfd)	86,400	1,440	24	1	5.227E+06	87,120	3,630	3,051,187	50,853	847.55	35.31
Acre in/min	0.017	-	-	-	1	0.017	0.001	0.584	0.01	-	-
Acre in/hr	0.992	0.001	-	-	60	1	0.042	35.02	0.584	0.01	-
Acre in/day	23.8	0.033	0.006	-	1,440	24	1	840.55	14.001	0.233	0.001
Cubic m/sec	0.028	-	-	-	1.71	0.029	0.001	1	0.017	-	-
Cubic m/min	1.7	0.028	-	-	102.8	1.71	0.071	60	1	0.017	0.001
Cubic m/hr	101.94	1.7	0.028	0.001	6,167	102.8	4.283	3,600	60	1	0.042
Cubic m/day	2446.6	40.78	0.68	0.028	148,018	2,467	102.79	86,400	1,400	24	1

**TABLE B-7 TEMPERATURE CONVERSION**

°F	°C	°F	°C	°F	°C	°F	°C	°F	°C
-60	-51	22	-5.6	50	10.0	78	25.6	160	71
-50	-46	23	-5.0	51	10.6	79	26.1	170	77
-40	-40	24	-4.4	52	11.1	80	26.7	180	82
-30	-34	25	-3.9	53	11.7	81	27.2	190	88
-20	-29	26	-3.3	54	12.2	82	27.8	200	92
-10	-23.0	27	-2.8	55	12.8	83	28.3	210	99
0	-17.8	28	-2.2	56	13.3	84	28.9	212	100
1	-17.2	29	-1.7	57	13.9	85	29.4	220	104
2	-16.7	30	-1.1	58	14.4	86	30.0	230	110
3	-16.1	31	-0.6	59	15.0	87	30.6	240	116
4	-15.6	32	0.0	60	15.6	88	31.1	250	121
5	-15.0	33	0.6	61	16.1	89	31.7	260	127
6	-14.4	34	1.1	62	16.7	90	32.2	270	132
7	-13.9	35	1.7	63	17.2	91	32.8	280	138
8	-13.3	36	2.2	64	17.8	92	33.3	290	143
9	-12.8	37	2.8	65	18.3	93	33.9	300	149
10	-12.2	38	3.3	66	18.9	94	34.4	310	154
11	-11.7	39	3.9	67	19.4	95	35.0	320	160
12	-11.1	40	4.4	68	20.0	96	35.6	330	166
13	-10.6	41	5.0	69	20.6	97	36.1	340	171
14	-10.0	42	5.6	70	21.1	98	36.7	350	177
15	-9.4	43	6.1	71	21.7	99	37.2	360	182
16	-8.9	44	6.7	72	22.2	100	37.8	370	188
17	-8.3	45	7.2	73	22.8	110	43	380	193
18	-7.8	46	7.8	74	23.3	120	49	390	199
19	-7.2	47	8.3	75	23.9	130	54	400	204
20	-6.7	48	8.9	76	24.4	140	60		
21	-6.1	49	9.4	77	25.0	150	66		

Degrees Celsius  $^{\circ}\text{C} = \frac{5}{9} (^{\circ}\text{F} - 32)$

Degrees Fahrenheit  $^{\circ}\text{F} = \frac{9}{5} ^{\circ}\text{C} + 32$

Degrees Kelvin  $^{\circ}\text{T} = ^{\circ}\text{C} + 273.2$

Degrees Rankine  $^{\circ}\text{R} = ^{\circ}\text{F} + 459.7$

**TABLE B-8 LENGTH CONVERSION**

Units of Length	in.	ft.	yd.	mile	mm	cm	m	km
inch	1	0.0833	0.0278	-	25.4	2.54	0.0254	-
foot	12	1	0.3333	-	304.8	30.48	0.3048	-
yard	36	3	1	-	914.4	91.44	0.9144	-
mile	-	5280	1760	1	-	-	1609.3	1.609
millimeter	0.0394	0.0033	-	-	1	0.100	0.001	-
centimeter	0.3937	0.0328	0.0109	-	10	1	0.01	-
meter	39.37	3.281	1.094	-	1000	100	1	0.001
kilometer	-	3281	1094	0.6214	-	-	1000	1

(1 micron = 0.001 millimeter)

## APPENDIX C: USEFUL FORMULAS

- Area of a Circle
- Circumference of a Circle
- Length of Circular Arc
- Area of Circle Sector
- Equation of a Circle (cartesian coordinates)
- Equation of a Line (quadratic formula)
- Basic Trigonometric Functions
- Area of an Ellipse
- Circumference of an Ellipse
- Area of a Triangle
- Area of a Trapezoid
- Area of a Parallelogram
- Surface Area of a Sphere
- Volume of a Sphere
- Surface Area of a Cylinder
- Volume of a Cylinder
- Surface Area of an Elliptical Tank
- Volume of an Elliptical Tank
- Surface Area of a Cone
- Volume of a Cone
- Surface Area of a Rectangular Solid
- Volume of a Rectangular Solid



## APPENDIX C: USEFUL FORMULAS

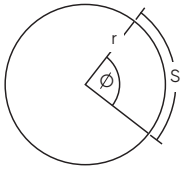

### Circle

$$\text{Diameter} = \frac{r}{2}$$

$$\text{Circumference} = \pi D = 2\pi r$$

$$\text{Area} = \pi r^2$$

Length of Circular Arc

$$S = \theta \times \left(\frac{\pi}{180}\right) \times r \quad \theta \text{ in degrees}$$

$$S = \theta \times r \quad \theta \text{ in radians}$$

Area of Circle Sector

$$A = r^2 \times \left(\frac{\theta}{360}\right) \times \pi \quad \theta \text{ in degrees}$$

$$A = r^2 \times \left(\frac{\theta}{2}\right) \quad \theta \text{ in radians}$$

Equation of a Circle (cartesian co-ordinates)  
- for a circle with center (j, k) and radius (r)

$$(x - j)^2 + (y - k)^2 = r^2$$

Equation of a line (quadratic formula)

$$ax + by + c = 0$$

or

$$ax^2 + bx + c = 0$$

$$x = \frac{-b \pm \sqrt{b^2 - 4ac}}{2a}$$

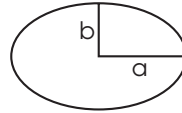

### Ellipse

$$\text{Area} = \pi \times a \times b$$

Circumference

$$= \pi (3(a + b) - \sqrt{(3a + b)(a + 3b)})$$

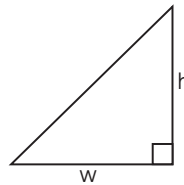

### Triangle

$$\text{Area} = \frac{w \cdot h}{2}$$

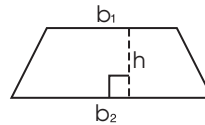

### Trapezoid

$$\text{Area} = \frac{1}{2} (b_1 + b_2) h$$

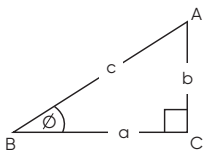

### Trigonometry

$$\sin \theta = \frac{b}{c}$$

$$\cos \theta = \frac{a}{c}$$

$$\tan \theta = \frac{b}{a}$$

Sine Law

$$\frac{a}{\sin A} = \frac{b}{\sin B} = \frac{c}{\sin C} = 2R$$

Cosine Law

$$c^2 = a^2 + b^2 - 2ab \cos C$$

$$b^2 = a^2 + c^2 - 2ac \cos B$$

$$a^2 = b^2 + c^2 - 2bc \cos A$$

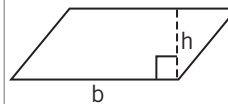

### Parallelogram

$$\text{Area} = b \cdot h$$

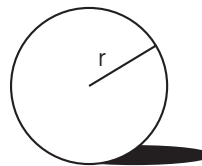

### Sphere

$$\text{Surface Area} = 4 \pi r^2$$

$$\text{Volume} = \frac{4}{3} \pi r^3$$

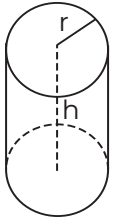

### Cylinder

$$\text{Surface Area} = (2 \pi r^2) + (2 \pi r h)$$

$$\text{Volume} = \pi r^2 h$$

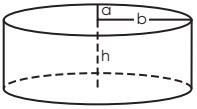

### Elliptical Tank

$$\text{Surface Area} = 2 \pi \left( \frac{\sqrt{a^2 + b^2}}{2} \right) h + (2 \pi ab)$$

$$\text{Volume} = \pi abh$$

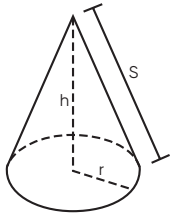

### Cone

$$\text{Surface Area} = \pi r s$$

$$\text{Volume} = \pi r^2 \frac{h}{3}$$

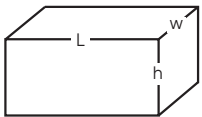

### Rectangular Solid

$$\text{Surface Area} = 2 (Lw + Lh + wh)$$

$$\text{Volume} = L w h$$

## APPENDIX D: ABBREVIATIONS

AGA	American Gas Association
ANSI	American National Standards Institute
API	American Petroleum Institute
ASME	American Society of Mechanical Engineers
ASTM	American Society for Testing and Materials
AWWA	American Water Works Association
BOCA	Building Officials and Code Administrators
BS	British Standards Institution
CPVC	Chlorinated poly (vinyl chloride) plastic or resin
CS	Commercial Standard, see Product Standard
CSA	Canadian Standards Association
DR	Dimension Ratio
DIN	German Industrial Norms
FHA	Federal Housing Administration or Farmers Home Administration
HDB	Hydrostatic design basis
HDS	Hydrostatic design stress
IAPD	International Association of Plastics Distributors
IAPMO	International Association of Plumbing and Mechanical Officials
IPC	International Plumbing Code
ISO	International Standards Organization
JIS	Japanese Industrial Standards
NSF	National Sanitation Foundation International
PPI	Plastics Pipe Institute
PS	Product Standard when in reference to a specification for plastic pipe and fittings. These specifications are promulgated by the U.S. Department of Commerce and were formerly known as Commercial Standards.
PVC	Poly-(vinyl chloride) plastic, resin or compound
PVCO	Molecularly Oriented Polyvinyl Chloride Plastic
RVCM	Residual Vinyl Chloride Monomer
SCS	Soil Conservation Service
SDR	Standard Dimension Ratio
SI	International System of Units
SPI	Society of the Plastics Industry, Inc.
UPC	Uniform Plumbing Code
USASI	United States of America Standards Institute (formerly American Standards Association)
WOG	Water, Oil, Gas

## APPENDIX E: TABLES & FIGURES

Table 1	Percent (%) Deflection for IPEX Centurion Pressure Pipe. . . . .	16
Table 2	Q-Line Flow Rates. . . . .	39
Table 3	Summary of Properties for PVC Pipe . . . . .	44
Table 4	Temperature Effects on PVC Pressure Pipe . . . . .	45
Table 5	Hazen-Williams “C”-Factors . . . . .	47
Table 6	Thrust Developed per 100 psi Pressure (lbs. force). . . . .	52
Figure 1	Stress Regression Line - Cell Class 12454 . . . . .	44
Figure 2	Pipe Material . . . . .	47
Figure 3	Resulting Cyclic-Failure Curves for PVC . . . . .	50, 58 & 61
Figure 4	Pipeline Profile. . . . .	62

## NOTES

## SALES AND CUSTOMER SERVICE

IPEX Inc.

Toll Free: (866) 473-9462

[ipexna.com](http://ipexna.com)

### About the IPEX Group of Companies

As leading suppliers of thermoplastic piping systems, the IPEX Group of Companies provides our customers with some of the largest and most comprehensive product lines. All IPEX products are backed by more than 50 years of experience. With state-of-the-art manufacturing facilities and distribution centers across North America, we have earned a reputation for product innovation, quality, end-user focus and performance.

Markets served by IPEX group products are:

- Electrical systems
- Telecommunications and utility piping systems
- PVC, CPVC, PP, PVDF, PE, ABS, and PEX pipe and fittings
- Industrial process piping systems
- Municipal pressure and gravity piping systems
- Plumbing and mechanical piping systems
- Electrofusion systems for gas and water
- Industrial, plumbing and electrical cements
- Irrigation systems

Products manufactured by IPEX Inc.

Bionax®, Blue904™, IPEX Centurion®, CycleTough®, Gold901™, IPEX Fusible™, Q-Line® and TerraBrute® CR and are trademarks of IPEX Branding Inc.

This literature is published in good faith and is believed to be reliable. However it does not represent and/or warrant in any manner the information and suggestions contained in this brochure. Data presented is the result of laboratory tests and field experience.

A policy of ongoing product improvement is maintained. This may result in modifications of features and/or specifications without notice.



**IPEX**  
by **alixis**

MNMNNAIP200502R2C  
© 2021 IPEX INDO033C